

JVC

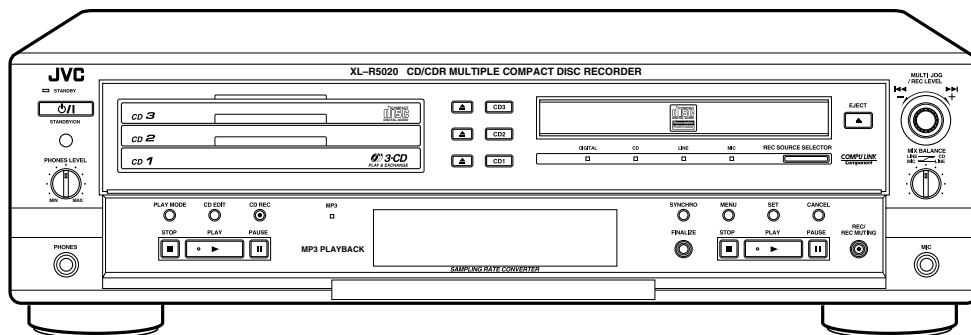

CD/CDR MULTIPLE COMPACT DISC RECORDER

XL-R5020BK

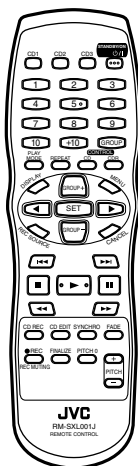

COMPACT
disc
DIGITAL AUDIO

COMPACT
disc
DIGITAL AUDIO
Recordable
ReWritable

3-CD
PLAY & EXCHANGE

COMPU LINK
Component

INSTRUCTIONS

For Customer Use:

Enter below the Model No. and Serial No. which are located either on the rear, bottom or side of the cabinet. Retain this information for future reference.

Model No. _____

Serial No. _____

LET0206-001A

[J]

Warnings, Cautions and Others

	CAUTION RISK OF ELECTRIC SHOCK DO NOT OPEN	
CAUTION: TO REDUCE THE RISK OF ELECTRIC SHOCK, DO NOT REMOVE COVER (OR BACK). NO USER SERVICEABLE PARTS INSIDE. REFER SERVICING TO QUALIFIED SERVICE PERSONNEL.		

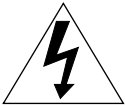

The lightning flash with arrowhead symbol, within an equilateral triangle is intended to alert the user to the presence of uninsulated "dangerous voltage" within the product's enclosure that may be of sufficient magnitude to constitute a risk of electric shock to persons.



The exclamation point within an equilateral triangle is intended to alert the user to the presence of important operating and maintenance (servicing) instructions in the literature accompanying the appliance.

WARNING: TO REDUCE THE RISK OF FIRE OR ELECTRIC SHOCK, DO NOT EXPOSE THIS APPLIANCE TO RAIN OR MOISTURE.

IMPORTANT FOR LASER PRODUCTS

1. CLASS 1 LASER PRODUCT
2. **DANGER:** Invisible laser radiation when open and interlock failed or defeated. Avoid direct exposure to beam.
3. **CAUTION:** Do not open the top cover. There are no user serviceable parts inside the Unit; leave all servicing to qualified service personnel.

CAUTION

To reduce the risk of electrical shocks, fire, etc.:

1. Do not remove screws, covers or cabinet.
2. Do not expose this appliance to rain or moisture.

Caution — STANDBY/ON button!

Disconnect the mains plug to shut the power off completely. The STANDBY/ON  button in any position does not disconnect the mains line. The power can be remote controlled.

For U.S.A.

This equipment has been tested and found to comply with the limits for a Class B digital device, pursuant to part 15 of the FCC Rules. These limits are designed to provide reasonable protection against harmful interference in a residential installation.

This equipment generates, uses and can radiate radio frequency energy and, if not installed and used in accordance with the instructions, may cause harmful interference to radio communications. However, there is no guarantee that interference will not occur in a particular installation. If this equipment does cause harmful interference to radio or television reception, which can be determined by turning the equipment off and on, the user is encouraged to try to correct the interference by one or more of the following measures:

Reorient or relocate the receiving antenna.

Increase the separation between the equipment and receiver.

Connect the equipment into an outlet on a circuit different from that to which the receiver is connected.

Consult the dealer or an experienced radio/TV technician for help.

Table of Contents

Introduction	2	Recording on a CD-R/CD-RW	21
About This Manual	2	Before You Start Recording	21
Precautions	2	Recording Manually—Standard Recording	22
Precautions on Disc Playback and Recording	3	Preparing for CD Synchronized Recording	25
Parts Identification	4	■ Changing the recording speed	25
Main Unit	4	■ Finalizing discs automatically	25
Display Window	4	Recording from 3-CD Changer	
Remote Control	5	—CD Synchronized Recording	26
Menu Configuration	5	■ Disc Direct Recording	26
Getting Started	6	■ One Track Recording	28
Supplied Accessories	6	■ Listening Edit Recording	29
Putting the Batteries into the Remote Control	6	■ Program Edit Recording	30
Connecting Other Components	7	Recording from the External Sources	
Basic Operations	9	—Sound Synchronized Recording	31
Turning On and Off the Power	9	Recording from the Two Sources Mixed	
Listening with Headphones	9	—Sound Mixing Recording	32
Playing Back Discs on 3-CD Changer	10	Other Recording Functions	33
Loading Discs	10	■ Setting auto-stop for analog	
Playing Back All Loaded Discs		Synchronized Recording	33
—Continuous Play	10	■ Finalizing a disc—CD-R/CD-RW	33
Basic Disc Operations	11	■ Unfinalizing a disc—only for CD-RW	34
Programing the Playing Order of the Tracks		■ Recording only one track from	
—Program Play	12	an external component	34
Playing at Random—Random Play	14	■ Recording track marks manually	34
Repeating Tracks—Repeat Play	15	■ Separating recording tracks automatically	35
Adjusting the Playback Speed—Pitch Control	15	■ Turning on or off sampling frequency rate	
Prohibiting Disc Ejection—Tray Lock	15	converter	35
Playing Back a Disc on CD Recorder	16	■ Recording skip marks onto a CD-R/CD-RW	
Loading a Disc	16	—Track Skip	35
Playing Back a Disc—Normal Play	16	■ Erasing tracks (only for CD-RW)	
Basic Disc Operations	17	—Track Erase	36
Repeating Tracks—Repeat Play	17	■ Erasing all tracks (only for CD-RW)	
Playing Back MP3 Discs on 3-CD Changer	18	—Disc Erase	36
About MP3	18	Using the Timer	37
Playing Back MP3 Discs	19	Setting the Clock	37
Basic MP3 Disc Operations	20	Using Daily Timer and Once Timer	38
Repeating Tracks—Repeat Play	20	COMPU LINK Remote Control System	40
		Maintenance	41
		Glossary	42
		Message	43
		Troubleshooting	44
		Specifications	45



Introduction

We would like to thank you for purchasing one of our JVC products. Before operating this unit, read this manual carefully and thoroughly to obtain the best possible performance from your unit, and retain this manual for future reference.

About This Manual

This manual is organized as follows:

- You can use the buttons and controls both on the remote control and on the unit for the same operations if they have the same or similar names (or marks), unless mentioned otherwise.
- Basic and common information that is the same for many functions is grouped in one place, and is not repeated in each procedure. For instance, we do not repeat the information about turning on/off the unit and others, which are explained in the section "Basic Operations" on page 9.
- The following marks are used in this manual:

	Gives you warning and caution to prevent from damage or risk of fire/electric shock. Furthermore, gives you information which is not good for obtaining the best possible performance from the unit.
	Gives you information and hints you had better know.

Precautions

Installation

- Install the unit in a place which is level, dry and neither too hot nor too cold—between 5°C (41°F) and 35°C (95°F).
- Install the unit in a location with adequate ventilation to prevent internal heat build-up in the unit.



DO NOT install the unit in a location near heat sources, or in a place subject to direct sunlight, excessive dust or vibration.

Power sources

- When unplugging the unit from the wall outlet, always pull the plug, not the AC power cord.



DO NOT handle the AC power cord with wet hands.

Moisture condensation

Moisture may condense on the lens inside the unit in the following cases:

- After starting heating in the room
 - In a damp room
 - If the unit is brought directly from a cold to a warm place
- Should this occur, the unit may malfunction. In this case, leave the unit turned on for a few hours until the moisture evaporates, unplug the AC power cord, then plug it in again.

Others

- Should any metallic object or liquid fall into the unit, unplug the AC power cord and consult your dealer before operating any further.
- If you are not going to operate the unit for an extended period of time, unplug the AC power cord from the wall outlet.



DO NOT disassemble the unit since there are no user serviceable parts inside.

If anything goes wrong, unplug the AC power cord and consult your dealer.

Precautions on Disc Playback and Recording

Playback

This unit has been designed to play back discs bearing the following logos:



CD ReWritable (CD-RW)



CD Recordable (CD-R)



Audio CD

In addition to the above discs, this unit can play back audio data recorded on CD-G (CD Graphics), CD-Text, CD-Extra and CD-R/CD-RW (single session) including MP3 tracks (files).

Notes on playing a CD-R or CD-RW:

- The built-in CD Recorder can play back **both finalized and unfinalized CD-Rs/CD-RWs**, however 3-CD Changer cannot play back **unfinalized CD-RWs**.
- Either on 3-CD Changer or on CD Recorder, you can play back CD-Rs or CD-RWs recorded on a personal computer only if they have been recorded in the CD audio format. Also 3-CD Changer can play back CD-Rs/CD-RWs (single session) including MP3 tracks (files).
- Some CD-Rs and CD-RWs may not be played back either on 3-CD Changer or on CD Recorder because of their disc characteristics, damage or stains.

Important notice:

- Continuous use of irregular-shaped discs (heart-shape, octagonal, etc.) can damage the disc rotating mechanism.



- CD-RWs may require a longer read-out time. This is caused by the fact that the reflectance of CD-RWs is lower than for regular CDs.
- MP3 discs require a longer read-out time. It differs depending on the complexity of the group/track configuration.

Recording

This unit has been designed to record on the discs bearing the following logos:



CD ReWritable (CD-RW)



CD Recordable (CD-R)

In addition to the logos shown above, the words shown below or their equivalent should also be indicated somewhere on the package or accompanying documentation.

- FOR CONSUMER
- FOR CONSUMER USE
- FOR MUSIC USE ONLY

Make sure the words, DIGITAL AUDIO, is shown on the discs.

The following discs cannot be used for recording:

- Discs bearing logos other than the above.
- Discs intended for professional use.
- Discs intended for recording computer data.

Important notice:

- The manufacturer assumes no liability whatsoever for any damage resulting from missed opportunity or accidental erasure that occurs while conducting recording or playback operations due to malfunctioning of or trouble in the unit, or for any incidental damage.
- Before recording on a CD-R, it is recommended to make a test recording using a CD-RW.
- If PCA (Power Calibration Area) or PMA (Program Memory Area) of the disc is already recorded fully, any further recording cannot be performed on this disc even though there are still unused memory spaces on the disc. (See "Glossary" on page 42.)



- DO NOT subject the unit to any shock or vibration while recording.
- DO NOT use a dusty or scratched CD-R/CD-RW for recording; otherwise, you cannot obtain the satisfactory recording quality.

It should be noted that it may be unlawful to re-record pre-recorded tapes, records, or discs without the consent of the owner of copyright in the sound or video recording, broadcast or cable program and in any literary, dramatic, musical, or artistic embodied therein.

Parts Identification

See pages in the parentheses for details.

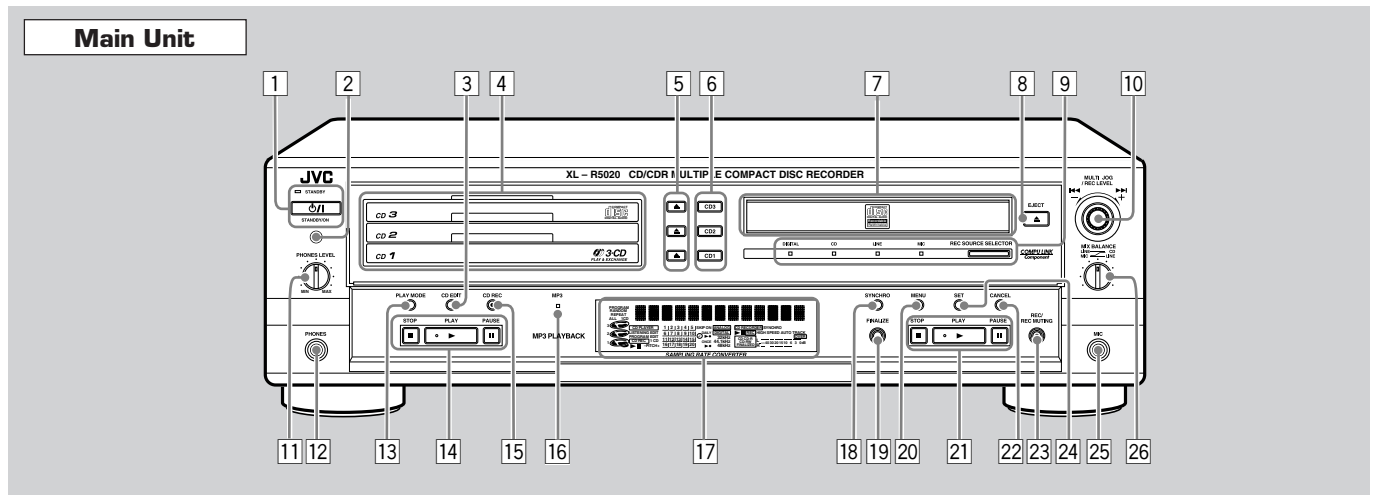

- | | |
|--|--|
| <ul style="list-style-type: none"> 1 STANDBY/ON button and STANDBY lamp (9, 38) 2 Remote sensor 3 CD EDIT button (29, 30) 4 3-CD Changer disc trays (CD1, CD2, CD3) (10, 19) 5 3-CD Changer disc eject buttons (CD1, CD2, CD3) (10, 15) 6 3-CD Changer disc number buttons (CD1, CD2, CD3) (9, 10, 19) 7 CD Recorder disc tray (16) 8 CD Recorder EJECT button 9 REC SOURCE SELECTOR button and recording source lamps (DIGITAL, CD, LINE, MIC) (22, 31, 32) 10 MULTI JOG / (11, 17, 20)
REC LEVEL +/- control (23, 32) 11 PHONES LEVEL control (9) 12 PHONES jack (9) 13 PLAY MODE button (12, 14) | <ul style="list-style-type: none"> 14 3-CD Changer operating buttons
STOP button
PLAY button
PAUSE button 15 CD REC button (26, 28) 16 MP3 lamp (19) 17 Display window (See below.) 18 SYNCHRO button (31) 19 FINALIZE button (33) 20 MENU button 21 CD Recorder operating buttons
STOP button
PLAY button
PAUSE button 22 CANCEL button 23 REC/REC MUTING button (22, 24, 30, 32) 24 SET button 25 MIC jack (21) 26 MIX BALANCE control (32) |
|--|--|

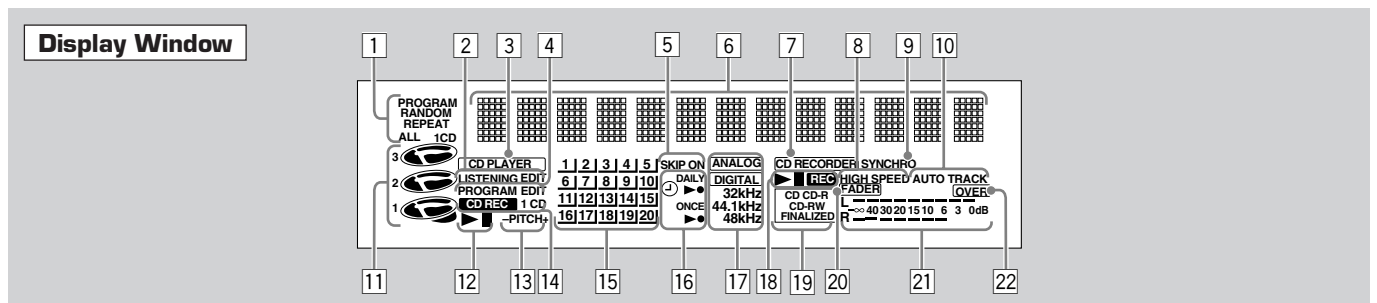

- | | |
|---|--|
| <ul style="list-style-type: none"> 1 Disc play mode indicators (12, 14, 15, 17, 20)
• PROGRAM, RANDOM, REPEAT (ALL/1CD/1) indicators 2 LISTENING EDIT indicator (29) 3 CD PLAYER indicator (10) 4 PROGRAM EDIT indicator (30) 5 SKIP ON indicator (35) 6 Display 7 CD RECORDER indicator (16) 8 HIGH SPEED indicator (25) 9 SYNCHRO indicator (26, 28, 31) 10 AUTO TRACK indicator (34) 11 Disc indicators (11) 12 3-CD Changer operating indicators
• (play), (pause) indicators 13 PITCH +/- indicators (15) | <ul style="list-style-type: none"> 14 Direct recording indicators (26, 28)
• CD REC 1CD, CD REC 1 indicators 15 Track number indicators 16 Timer indicators (38, 39)
• (timer), DAILY (playing) and (recording),
ONCE (playing) and (recording) 17 Signal indicators
• ANALOG, DIGITAL, 32 kHz, 44.1 kHz, 48 kHz indicators 18 CD Recorder operating indicators
• (play), (pause), REC (recording) indicators 19 CD Recorder disc type indicators (16)
• CD, CD-R, CD-RW, FINALIZED indicators 20 FADER indicator (24) 21 Level meter 22 OVER indicator (23) |
|---|--|

Remote Control

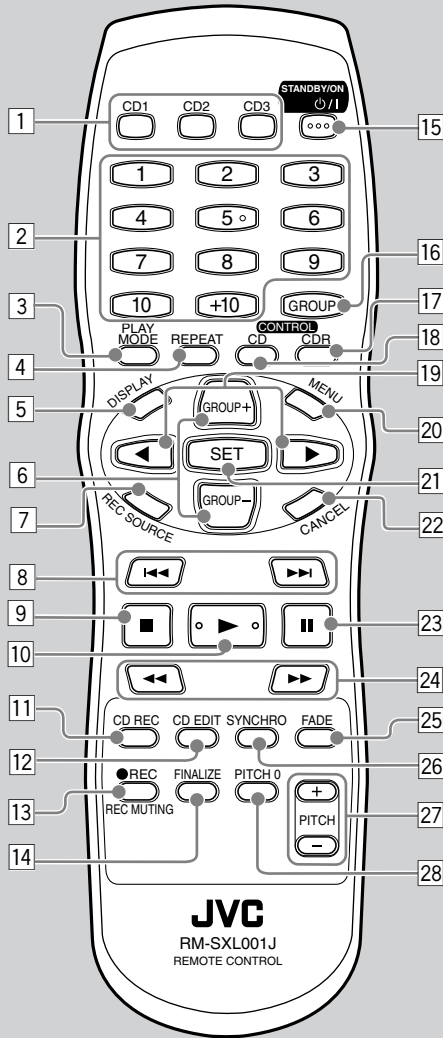

- 1 Disc number buttons (CD1, CD2, CD3) (9, 11, 19)
- 2 Number buttons (11, 17, 20)
- 3 PLAY MODE button (12, 14)
- 4 REPEAT button (15, 17, 20)
- 5 DISPLAY button (20, 24)
- 6 GROUP +/- buttons (20)
- 7 REC SOURCE button (22, 31, 32)
- 8 ►► / ◀◀ (fast reverse/fast forward) buttons (11, 17, 20)
- 9 ■ (stop) button
- 10 ► (play) button
- 11 CD REC button (26, 28)
- 12 CD EDIT button (29, 30)
- 13 ● REC/REC MUTING button (22, 24, 30, 32)
- 14 FINALIZE button (33)
- 15 STANDBY/ON button (9, 38)
- 16 GROUP button (20)
- 17 CONTROL CDR button (17)
- 18 CONTROL CD button
- 19 ► / ◀ buttons
- 20 MENU button
- 21 SET button
- 22 CANCEL button
- 23 || (pause) button
- 24 ►► / ◀◀ (fast reverse/fast forward) buttons (11, 17, 20)
- 25 FADE button (24)
- 26 SYNCHRO button (31)
- 27 PITCH +/- buttons (15)
- 28 PITCH 0 button (15)

IMPORTANT

When using the remote control to operate 3-CD Changer or CD Recorder, press CONTROL CD or CONTROL CDR before pressing other operating buttons (8, 9, 10, 23, 24);

- To operate 3-CD Changer, press CONTROL CD.
- To operate CD Recorder, press CONTROL CDR.

Menu Configuration

You can show a menu on the display by pressing MENU while neither 3-CD Changer nor CD Recorder are playing (in stop mode). By turning MULTI JOG ►► / ◀◀ on the unit, or pressing ► or ◀ on the remote control, menu items change as follows. See pages in the parentheses for details.

TRACK ERASE (36)	↔	DISC ERASE (36)	↔	UNFINALIZE (34)	↔
TRACK SKIP (35)	↔	DUB-SPEED (25)	↔	AUTO FINALIZE (25)	↔
DISC DUB MODE (27)	↔	AUTO TRACK (34)	↔	TRACK SPACE (35)	↔
CONVERTER (35)	↔	DIG-IN SYNC (34)	↔	ANALOG SYNC (33)	↔
SET DEFAULT*	↔	CLOCK/TIMER (37)	↔	Back to the beginning	

* You can reset all of the menu items to the initial settings when you purchased this unit. To reset:

1. While 3-CD Changer and CD Recorder are in stop mode, press MENU.
2. Turn MULTI JOG ►► / ◀◀ on the unit, or press ► or ◀ on the remote control to select "SET DEFAULT," then press SET. "SET DEFAULT ?" appears on the display.
 - To cancel the reset, press CANCEL.
3. Press SET. All of the menu items are reset to the initial settings when you purchased this unit.

Initial settings

Menu item	Initial setting
DUB-SPEED	HIGH
AUTO FINALIZE	OFF
DISC DUB MODE	NORMAL
AUTO TRACK	ON
TRACK SPACE	ON
CONVERTER	ON
DIG-IN SYNC	ALL
ANALOG SYNC	START

Getting Started

Supplied Accessories

After unpacking, check to be sure that you have all the following items.

The number in the parentheses indicates the quantity of the pieces supplied.

- Remote control—RM-SXL001J (1)
- Batteries—R6P(SUM-3)/AA(15F) (2)
- Audio cord with RCA pin plugs (2)
- Cable with monaural mini-plugs (1)

If anything is missing, consult your dealer immediately.

Putting the Batteries into the Remote Control

Insert the batteries—R6(SUM-3)/AA(15F)—into the remote control, by matching the polarity (+ and -) on the batteries with the + and - markings on the battery compartment.

When the remote control can no longer operate the unit, replace both batteries at the same time.

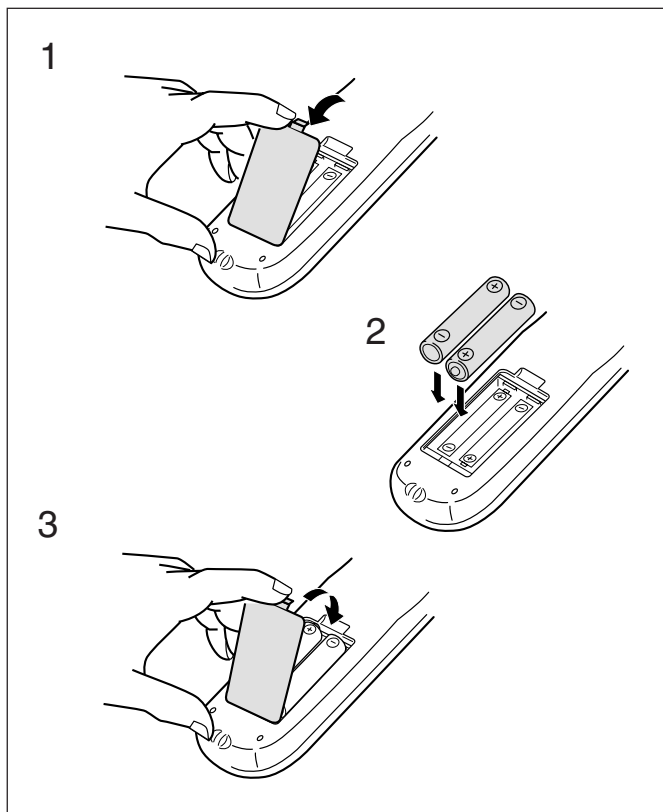
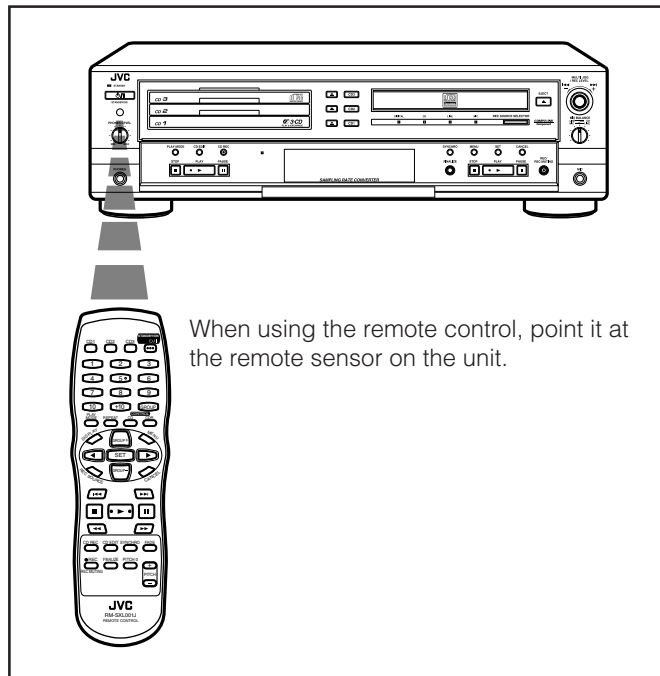

- DO NOT use an old battery together with a new one.
- DO NOT use different types of batteries together.
- DO NOT expose batteries to heat or flame.
- DO NOT leave the batteries in the battery compartment when you are not going to use the remote control for an extended period of time. Otherwise, it will be damaged from battery leakage.

Connecting Other Components

When you connect and use other components, refer also to the manuals supplied with them.



- DO NOT connect other components while the power is on.
- DO NOT plug in any component until all connections are complete.

To connect an analog component

White plugs and jacks are for left audio signals, and red ones for right audio signals.

You can enjoy playback and recording on the connected component.

By using audio cords with RCA pin plugs (supplied), connect:

- Between the audio input jacks on the other component and the LINE OUT (PLAY) jacks.
- Between the audio output jacks on the other component and the LINE IN (REC) jacks.

When connecting a JVC audio component equipped with the COMPU LINK remote control system

You can use COMPU LINK remote control system (see page 40) by connecting this unit and a JVC audio component through the COMPU LINK-4 (SYNCHRO) jacks using cables with monaural mini-plugs in addition to the audio cord connection.

When using COMPU LINK remote control system for operating a receiver equipped with TAPE and/or CDR jacks, set the MODE selector to the appropriate position (see below).

- **Set the MODE selector to "CDR"** when connecting to the CDR input/output jacks on the receiver. The connected receiver (or amplifier) recognizes this unit as a CD recorder.
- **Set the MODE selector to "TD"** when connecting to the TAPE/MD or TAPE input/output jacks on the receiver. The connected receiver (or amplifier) recognizes this unit as a cassette deck.

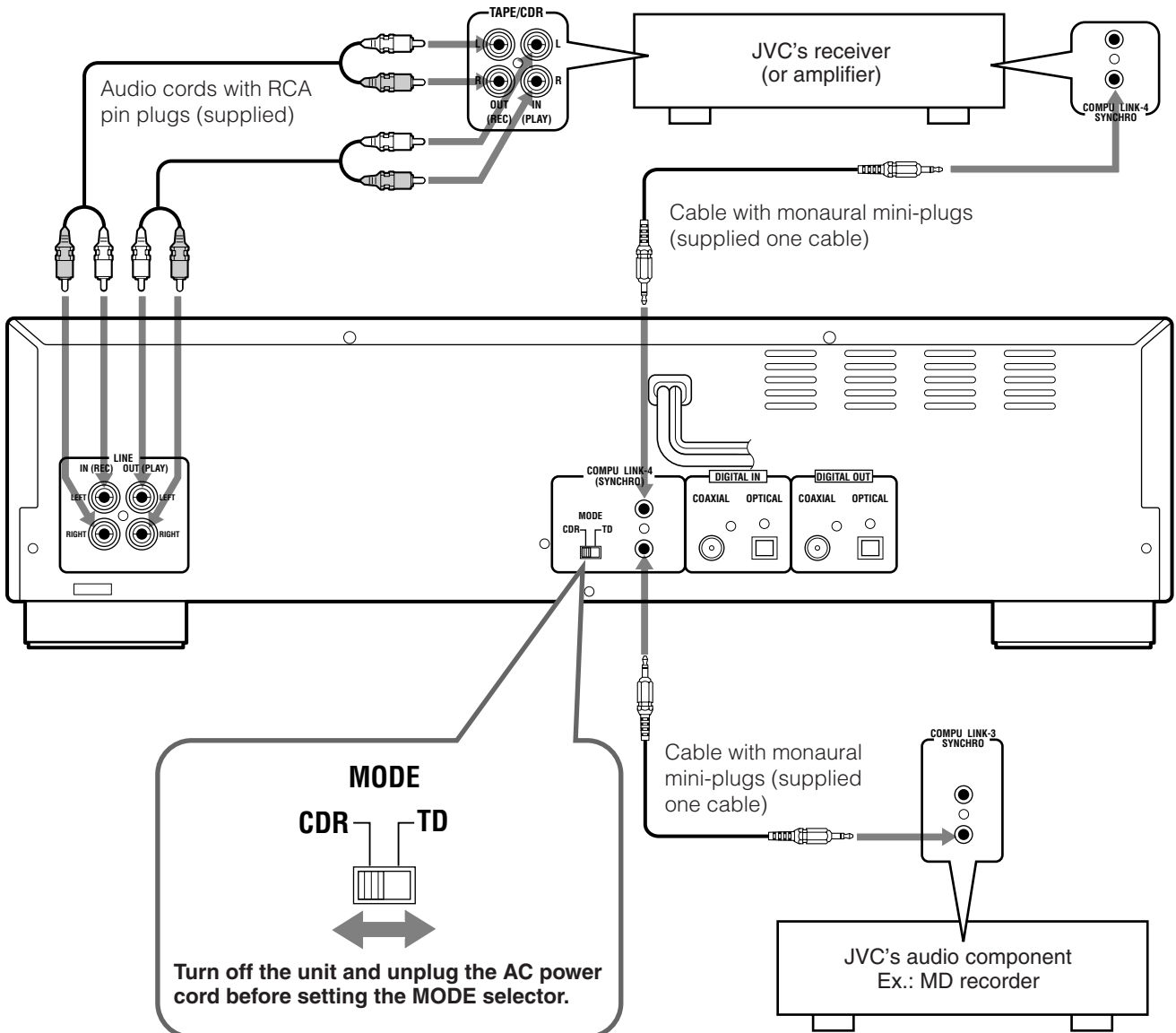

To connect digital components

This unit is equipped with two types of digital input/output terminals—coaxial and optical.

When connecting a digital component equipped with a digital output terminal

The following connection allows you to perform digital-to-digital recording on this unit (through the digital terminals).

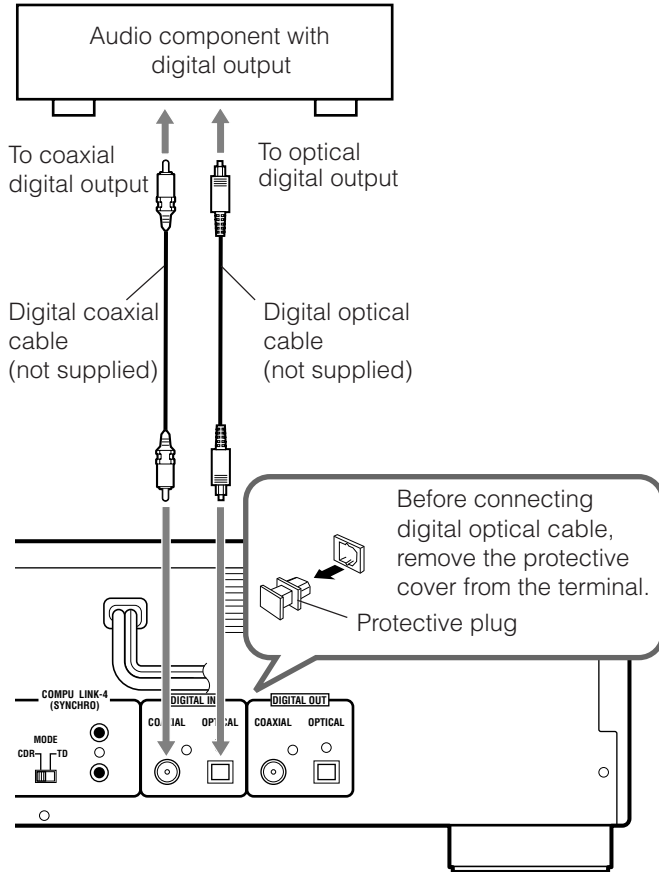

- When playing back an MP3 disc, digital signal cannot be output from this unit. Connect also this unit to LINE OUT (PLAY) jacks by using audio cords with RCA pin plugs (supplied).
- Digital signal cannot be output through the DIGITAL OUT terminals while recording digitally from an external component.

When connecting a digital component equipped with a digital input terminal

The following connection allows you to perform digital-to-digital recording (from 3-CD Changer onto the other component).

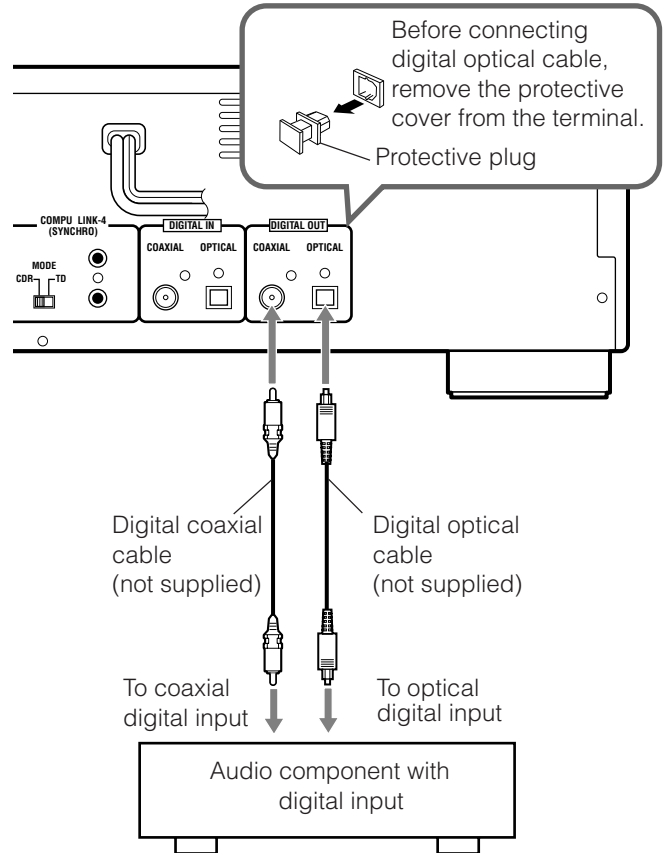

When this unit cannot recognize a component connected to the DIGITAL IN COAXIAL or OPTICAL terminal, "UNLOCK" appears on the display. If this happens, press PLAY ► for 3-CD Changer so that the connected component will be recognized.

NOW, you can plug in the unit and other connected components FINALLY!

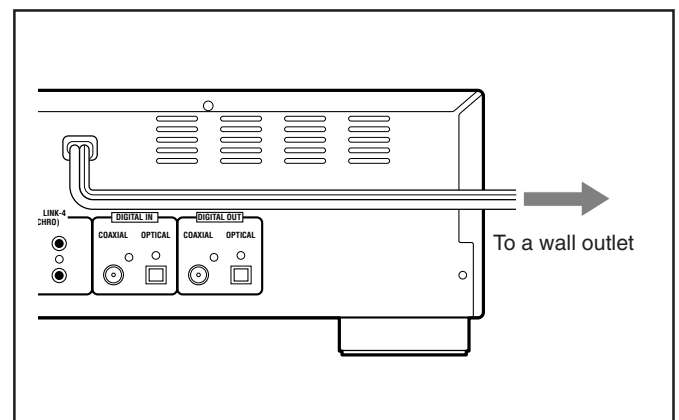

Basic Operations

IMPORTANT

When using operating buttons (▶, ■, II) on the remote control, check which indicator lights up on the display—CD PLAYER (3-CD Changer) or CD RECORDER. If the incorrect indicator is lit, press CONTROL CD or CONTROL CDR to select the correct target source.

On the unit:

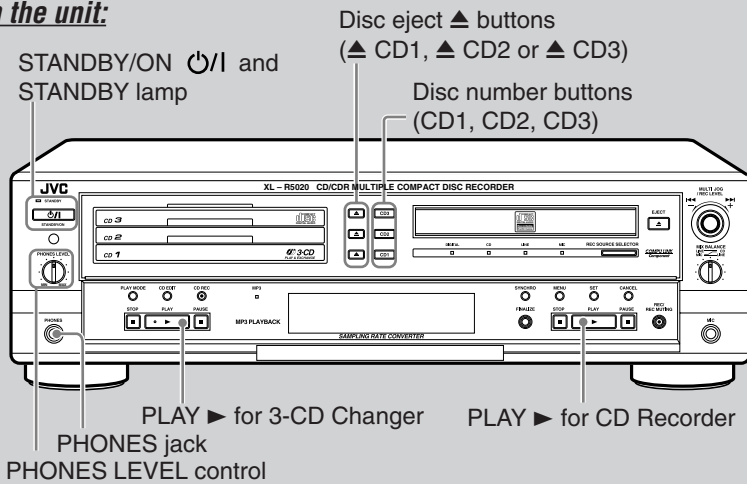

Remote control:

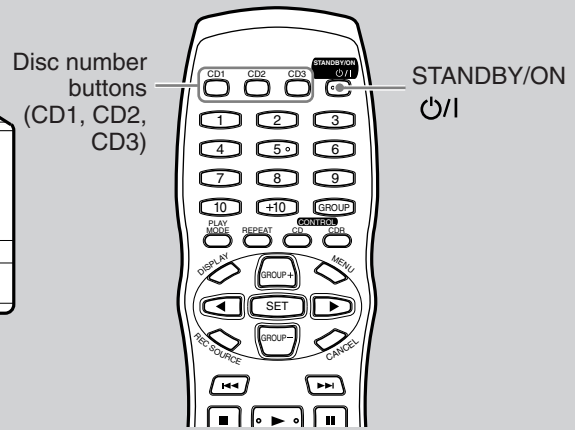

Before operating the unit any further, first set the clock built in this unit (see page 37).

Turning On and Off the Power

To turn on the unit without playing, press STANDBY ON \odot/I so that the STANDBY lamp on the unit goes off.

- Last selected disc tray is selected again.

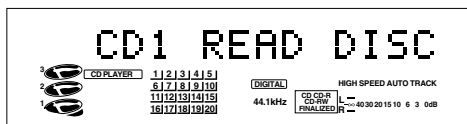

Ex.: When previously selected disc is CD1 on 3-CD Changer.

To start playback after turning on the unit, press one of the following buttons.

Disc number buttons (CD1, CD2 or CD3)

—3-CD Changer starts continuous play from the selected disc.

PLAY \blacktriangleright for 3-CD Changer on the unit

—3-CD Changer starts playing the last selected disc (if a disc is loaded on the disc tray).

PLAY \blacktriangleright for CD Recorder on the unit

—CD Recorder starts playing if a disc is loaded on the CD Recorder tray.

- Pressing 3-CD Changer disc eject \blacktriangle buttons (\blacktriangle CD1, \blacktriangle CD2 or \blacktriangle CD3) or EJECT \blacktriangle for CD Recorder also turns on the unit and opens the corresponding disc tray, but the currently selected disc does not change, and the playback will not start.

To turn off the unit (on standby), press STANDBY/ON \odot/I again so that the STANDBY lamp lights red and current time appears on the display.

- A little power is always consumed even while the unit is in standby mode.

To switch off the power supply completely, unplug the AC power cord from the AC outlet.



When you unplug the AC power cord or if a power failure occurs, the clock will be reset to "AM 12:00" and the timer settings will be erased. If this happens, set the clock and the timer again.

Listening with Headphones

When this unit is not connected to a receiver (amplifier), you can listen to the sound reproduced on 3-CD Changer or CD Recorder by connecting a pair of headphones to PHONES jack on the unit.

To increase the volume level, turn PHONE LEVEL control to the right.

To decrease the volume level, turn PHONE LEVEL control to the left.

- Be sure to turn down PHONE LEVEL fully before connecting or putting on the headphones.

Playing Back Discs on 3-CD Changer

- For the playable discs on 3-CD Changer, refer to page 3.
- This 3-CD Changer can play back MP3 discs. You can place either an audio disc or an MP3 disc on any disc tray. See page 18 for details.

IMPORTANT

When using operating buttons (▶, ■, ||) on the remote control for the following operations, check the CD PLAYER (3-CD Changer) indicator lights up on the display. If not, press CONTROL CD to select 3-CD Changer.

Loading Discs

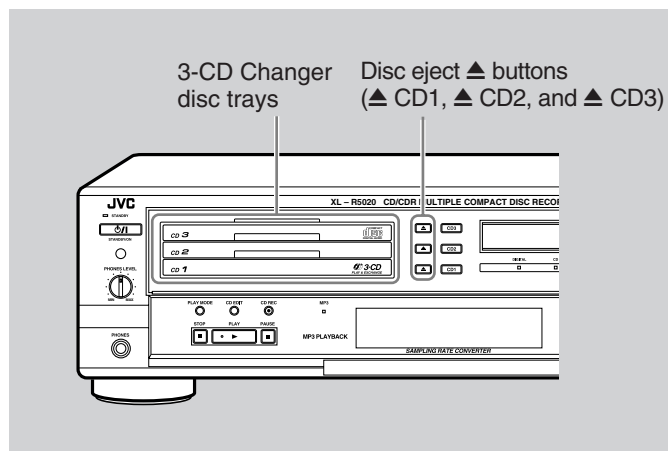

Playing Back All Loaded Discs—Continuous Play

On the unit:

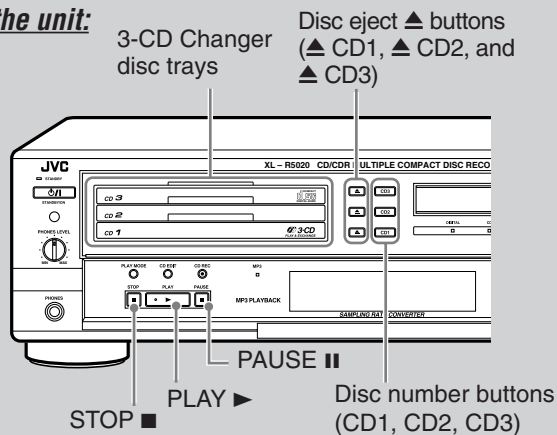

On the unit ONLY:

- 1 Press one of the 3-CD Changer disc eject ▲ buttons (▲ CD1, ▲ CD2, and ▲ CD3) for the disc tray you want to load a disc onto.
The unit automatically turns on and the selected disc tray comes out.

- 2 Load a disc correctly on the circle of the disc tray, with its label side up.

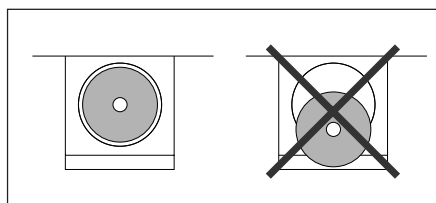
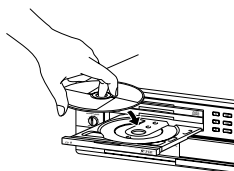

- When using a CD single (8 cm), place it on the inner circle of the disc tray.

- 3 Press the same 3-CD Changer disc eject button (▲ CD1, ▲ CD2, or ▲ CD3) you have pressed in step 1.

The disc tray closes.

- When loading more than one disc continuously, press the 3-CD Changer disc eject button (▲ CD1, ▲ CD2, or ▲ CD3) for the next tray you want to load another disc onto. The first disc tray automatically closes and the next disc tray comes out.

- 1 Load discs onto the 3-CD Changer disc trays (see the left).
- 2 Press one of the disc number buttons (CD1, CD2 or CD3).

The CD PLAYER indicator lights up on the display and 3-CD Changer reads out the disc contents. The playback starts with the first track of the selected disc.

- 3-CD Changer stops playing after playing back all loaded discs once.

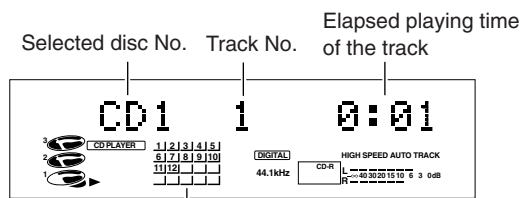

All track numbers of the selected disc*

- * Track numbers already played go off from the display. If a disc includes more than 20 tracks, the track numbers exceeding 20 cannot be shown.

- Pressing PLAY ▶ for 3-CD Changer also starts playing back with the currently selected disc (the disc marked with ◀ on the display).

To stop playback for a moment, press PAUSE ||. To resume play, press PLAY ▶. The playback starts from where it has been stopped.

To stop playback, press STOP ■.

To remove a disc, press the corresponding 3-CD Changer disc eject ▲ button (▲ CD1, ▲ CD2, or ▲ CD3).

Remote control:

Disc number buttons (CD1, CD2, CD3)

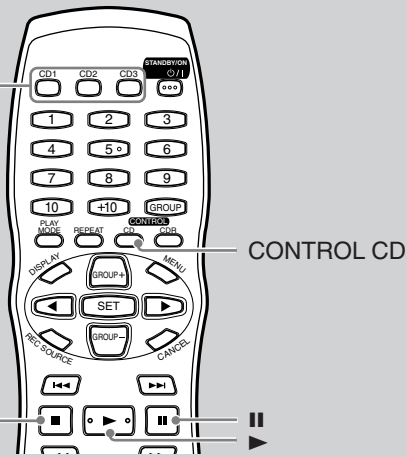

CONTROL CD

1 Load discs onto the 3-CD Changer disc trays (see page 10).

2 Press one of the disc number buttons (CD1, CD2 or CD3).

The CD PLAYER indicator lights up on the display and 3-CD Changer reads out the disc contents. The playback starts with the first track of the selected disc.

- 3-CD Changer stops playing after playing back all loaded discs once.
- Pressing ► also starts playing back with the currently selected disc (the disc marked with ◀ on the display).

To stop playback for a moment, press ■. To resume play, press ►. The playback starts from where it has been stopped.

To stop during play, press ■.

About disc indicators

The disc indicator rotates when a disc on the corresponding disc tray plays back (in this example, CD1). It goes off when no disc is loaded on the CD1 disc tray.



This indicates the currently selected disc tray.



- When 3 discs are loaded on the disc trays, they are played in one of the following sequences.
 - When CD 1 is pressed : CD 1 ⇒ CD 2 ⇒ CD 3 (then stops)
 - When CD 2 is pressed : CD 2 ⇒ CD 3 ⇒ CD 1 (then stops)
 - When CD 3 is pressed : CD 3 ⇒ CD 1 ⇒ CD 2 (then stops)
- * If no disc is on a disc tray, 3-CD Changer skips such an empty tray.

Basic Disc Operations

To start playing a disc during playback of another disc

Press one of the disc number buttons (CD1, CD2 or CD3). The selected disc starts playing.

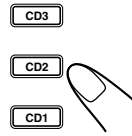

On the unit

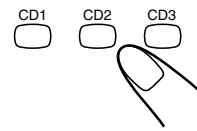

From the remote control

To go to another track

On the unit:

Turn MULTI JOG ►► / ◀◀.

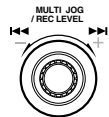

From the remote control:

Press ►► or ◀◀.

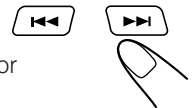

- ►►: Skips to the beginning of the next or succeeding tracks.
- ◀◀: Goes back to the beginning of the current or previous tracks.



While the last track of a disc is playing, turning MULTI JOG ►► / ◀◀ on the unit to the right or pressing ►► on the remote control goes to the first track of the next disc.

To go to another track directly

From the remote control ONLY:

Select a track number using the number buttons.

Ex.: For track number 5, press 5.

For track number 15,

press +10, then 5.

For track number 20,

press +10, then 10.

For track number 32,

press +10, +10, +10, then 2.

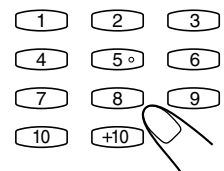

To locate a particular point in a track during play

From the remote control ONLY:

Press and hold ►► or ◀◀.

- ►►: Fast-forwards the tracks.
- ◀◀: Fast-reverses the tracks.

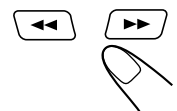

- If you press and hold ►► or ◀◀ during pause, no sound comes out. When you release your finger from the button, the pause mode will resume.
- While the last track of a disc is playing, holding down ►► goes to the first track of the next disc.

Programming the Playing Order of the Tracks—Program Play

You can arrange the playing order in which the tracks play before you start playing. You can program up to **32** tracks. The programmed tracks can be also recorded (see page 30).

- Program Play is possible only on 3-CD Changer.

IMPORTANT

When using operating buttons (▶, ■, ||) on the remote control for the following operations, check the CD PLAYER (3-CD Changer) indicator lights up on the display. If not, press CONTROL CD to select 3-CD Changer.

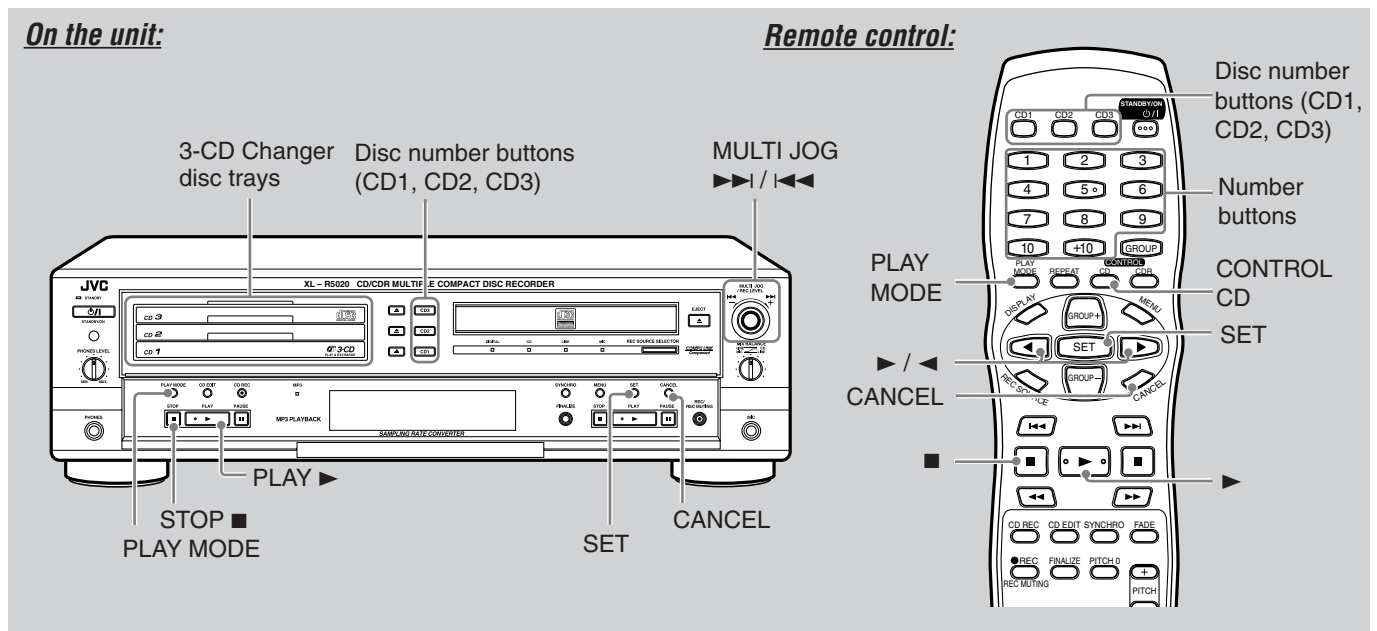

You cannot make a program using MP3 discs.

1 Load discs onto the 3-CD Changer disc trays.

- If the current disc is CD Recorder:
- On the unit: Press PLAY ▶, then STOP ■ for 3-CD Changer.
- From the remote control: Press CONTROL CD.

2 Press PLAY MODE repeatedly until “PG” appears on the display.

- The PROGRAM indicator also lights up on the display.
- If a program has been memorized, it is called up. If no program is stored, “NO PROGRAM” appears on the display.

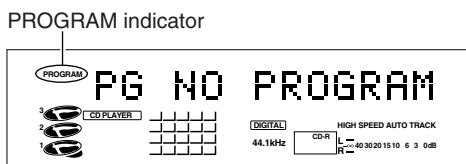

- Each time you press the button, the play mode changes as follows:



3 Press SET.

The disc number position starts flashing.

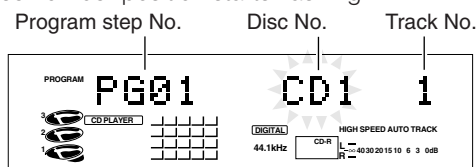

4 Select a disc number you want.

On the unit:

Turn MULTI JOG ▶▶ / ◀◀, then press SET.

From the remote control:

Press ▶ or ◀, then press SET.

The track number position starts flashing.

- You can also select a disc number by pressing one of the disc number buttons (CD1, CD2, CD3). When using the disc number buttons (CD1, CD2, CD3), you do not have to press SET.

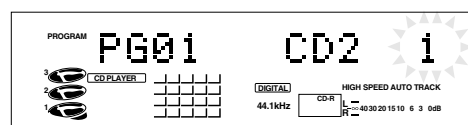

Ex.: When selecting “CD2.”

5 Select a track number you want.

On the unit:

Turn MULTI JOG ▶▶ / ◀◀, then press SET.

From the remote control:

Press ▶ or ◀, then press SET.

- You can also select a track number by using the number buttons on the remote control. When using the number buttons, you do not have to press SET.

6 Repeat steps 4 and 5 to program more tracks.

- You can program up to 32 tracks.

7 Start playing.

On the unit:

Press **PLAY ►** for 3-CD Changer.

From the remote control:

Press **►**.

The tracks are played in the order you have programmed. Program Play stops when all the programmed tracks are played once (unless Repeat Play is activated—see page 15).

To stop playing, press **STOP ■** for 3-CD Changer on the unit or **■** on the remote control.

To exit from Program Play, before or after play, press **PLAY MODE** once or twice so that the unit enters another play mode (Random Play or Continuous Play).



- You cannot program the track numbers exceeding 99.
- If you try to program a 33rd step, "MEMORY FULL" will appear on the display.
- If you have a track number which does not exist, or if you select an empty disc tray number, such a step may be programmed but skipped during the Program Play.
- MP3 disc cannot be played back even though they can be programmed. If this unit detects an MP3 disc during Program Play, the playback will stop. ("CANNOT PLAY" appears on the display.)

To modify the program

You can modify the program before or after play.

To add steps, select the disc number and the track number you want to add by following steps 3 to 6 on page 12.

To erase the last step, press **CANCEL** twice.

- The track number of the last step is erased by pressing **CANCEL** once, and pressing it again erases the disc number of the last step.

To erase a particular programmed track, select the program step number you want to erase by turning **MULTI JOG ►► / ◀◀** on the unit or pressing **►** or **◀** on the remote control, then press **CANCEL**.

To erase all programmed tracks, press **CANCEL** repeatedly until "PG NO PROGRAM" appears on the display.

- The program you have made is also erased:
 - when unplugging the AC power cord.
 - when ejecting the currently selected disc tray.

To check the programmed contents

On the unit:

Turn **MULTI JOG ►► / ◀◀** before starting playback.

From the remote control:

Press **►** or **◀** before starting playback.

- **►►** or **►** : Shows the programmed tracks in the programmed order.
- **◀◀** or **◀** : Shows them in the reverse order.

Playing at Random—Random Play

The tracks of all loaded discs in 3-CD Changer will play at random.

- Random Play is possible only on 3-CD Changer.

IMPORTANT

When using operating buttons (▶, ■, ||) on the remote control for the following operations, check the CD PLAYER (3-CD Changer) indicator lights up on the display. If not, press CONTROL CD to select 3-CD Changer.

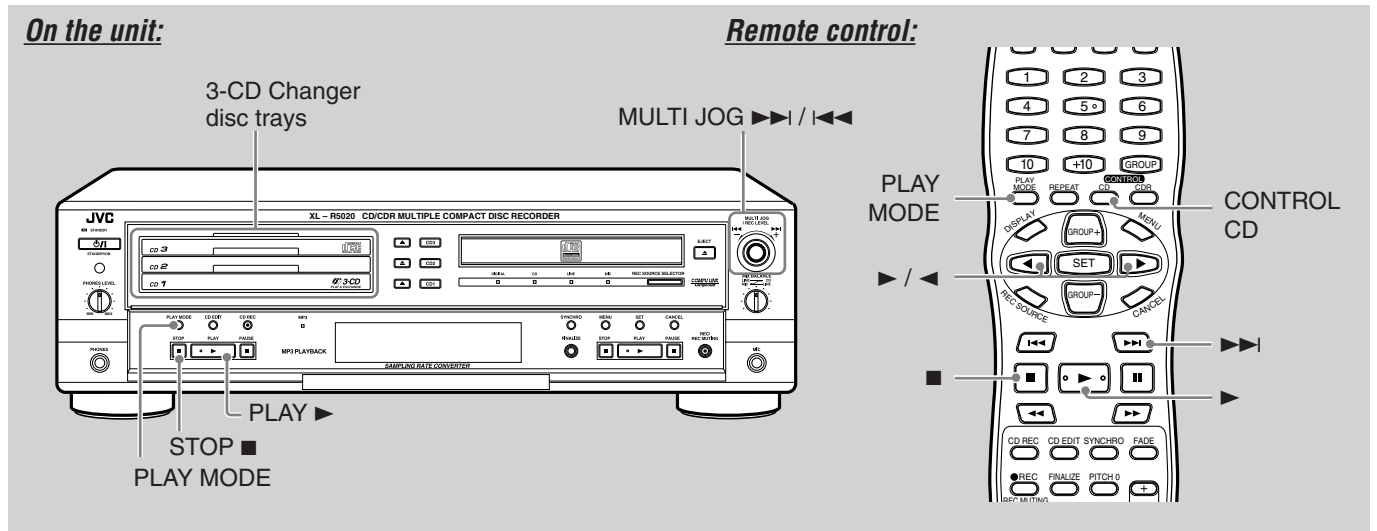

You cannot use Random Play for MP3 discs.

1 Load discs onto the 3-CD Changer disc trays.

If the current disc is CD Recorder:

- On the unit: Press PLAY ▶, then STOP ■ for 3-CD Changer.
- From the remote control: Press CONTROL CD.

2 Press PLAY MODE repeatedly until “CD RANDOM” appears on the display.

The RANDOM indicator also lights up on the display.

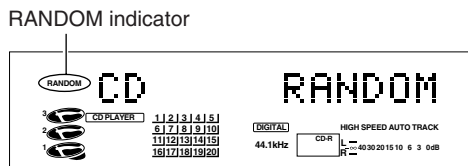

- Each time you press the button, the play mode changes as follows:



3 Start playing.

On the unit:

Press PLAY ▶ for 3-CD Changer.

From the remote control:

Press ▶.

The tracks are played at random up to 99 tracks. Random Play stops when all the tracks are played once (unless Repeat Play is activated—see page 15).

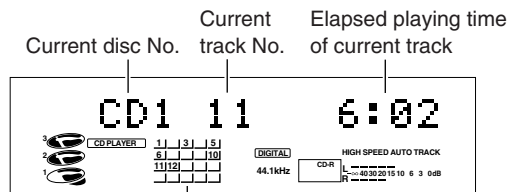

Track numbers already played go off.

To go to another track, turn MULTI JOG ▶▶ / ◀◀ on the unit to the right or press ▶▶ on the remote control.

- Even if you turn MULTI JOG ▶▶ / ◀◀ on the unit to the left or press ◀◀, you cannot go back to the previous tracks.

To stop Random Play during play, press STOP ■ for 3-CD Changer or ■ on the remote control.

- Ejecting the currently playing disc also cancels Random Play.

To exit from Random Play, before or after play, press PLAY MODE once or twice so that the unit enters another play mode (Program Play or Continuous Play).



- The track numbers exceeding 99 are not played back.
- The skip marked tracks are not played back.
- You cannot select track numbers by using the number buttons.
- If this unit detects an MP3 disc during Random Play, the playback will stop. (“CANNOT PLAY” appears on the display.)

Repeating Tracks—Repeat Play

You can repeat playing all the discs, the program or the individual track currently playing as many times as you like.

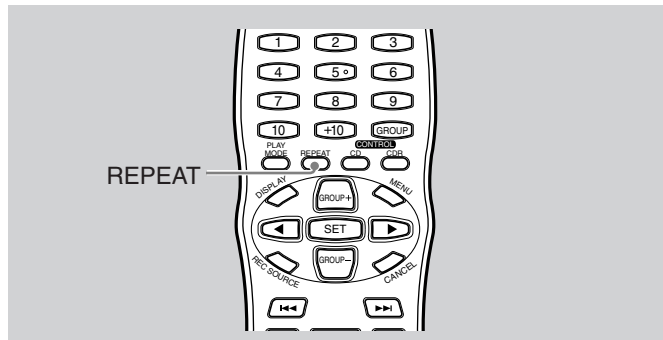

From the remote control ONLY:

Press REPEAT during or before playing.

The REPEAT indicator lights up on the display.

- Each time you press the button, Repeat Play changes as follows:

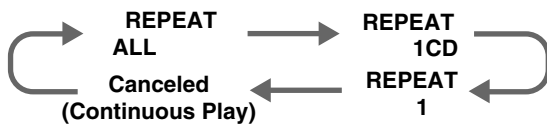

- REPEAT ALL:** Repeats all the tracks on all the loaded discs (continuously or at random), or all the tracks in the program.
- REPEAT 1CD*:** Repeats all the tracks on one disc.
- REPEAT 1:** Repeats one track.

* REPEAT 1CD is not used for Program Play and Random Play.

To cancel Repeat Play, press REPEAT repeatedly until the REPEAT indicator goes off from the display.

- Ejecting the currently playing disc also cancels Repeat Play.

Adjusting the Playback Speed—Pitch Control

You can change the playback speed up to 12% faster or 12% slower when playing back a disc on 3-CD Changer. This function will be useful when you want to enjoy singing along.

- You can also record tracks with adjusted speed on this CD Recorder using analog recording.

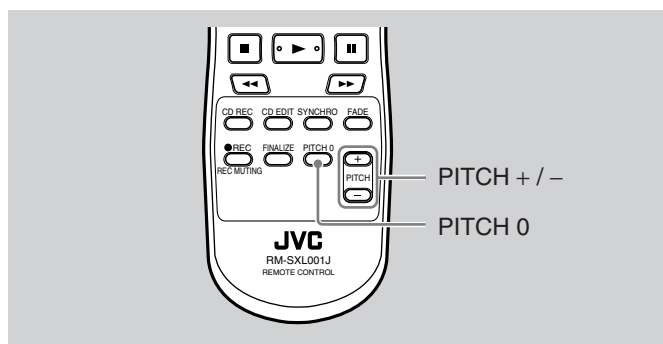

From the remote control ONLY:

Press PITCH + or – during play.

- PITCH +:** Increases the playback speed (pitch) up to 12% faster. The PITCH + indicator lights up on the display.
- PITCH –:** Decreases the playback speed (pitch) up to 12% slower. The PITCH – indicator lights up on the display.

To restore normal speed playback, press PITCH 0.

The PITCH + or PITCH – indicator goes off from the display.

- Ejecting the currently playing disc also restores the normal playback speed.



- During CD Synchronized Recording from 3-CD Changer to CD Recorder, playback speed adjustment is automatically canceled temporarily. The PITCH + or PITCH – indicator goes off from the display.
- Pitch Control is available only for analog signal. No signal comes out of the DIGITAL OUT terminals.
- Pitch Control is not available while playing back a disc on CD Recorder.
- Pitch Control is not available for MP3 discs.

Prohibiting Disc Ejection—Tray Lock

You can prohibit the disc ejection both from 3-CD Changer and from CD Recorder.

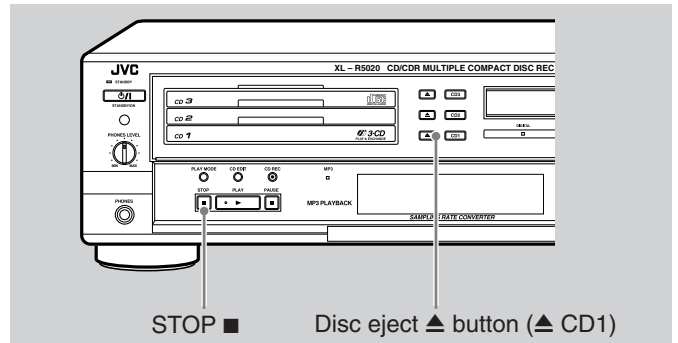

On the unit ONLY:

Press STOP ■ for 3-CD Changer and disc eject ▲ CD1 at the same time while the unit is in standby mode.

- “TRAY LOCKED” appears on the display for a while, and the loaded discs (both in 3-CD Changer and in CD Recorder) are locked.

TRAY LOCKED

To cancel the prohibition and unlock the discs, press STOP ■ for 3-CD Changer and disc eject ▲ CD1 at the same time again while the unit is in standby mode.

- “TRAY UNLOCKED” appears on the display for a while, and the loaded discs (both in 3-CD Changer and in CD Recorder) are unlocked.



- If you try to eject discs when trays are locked, “TRAY LOCKED” appears on the display to inform you that the Tray Lock is in use.
- Tray Lock is released when unplugging the power cord.

Playing Back a Disc on CD Recorder

- You can play back both finalized and unfinalized discs on CD Recorder.
- Program Play, Random Play and Pitch Control cannot be used on CD Recorder.

IMPORTANT

When using operating buttons (▶, ■, ||) on the remote control for the following operations, check the CD RECORDER indicator lights up on the display. If not, press CONTROL CDR to select CD Recorder.

Loading a Disc

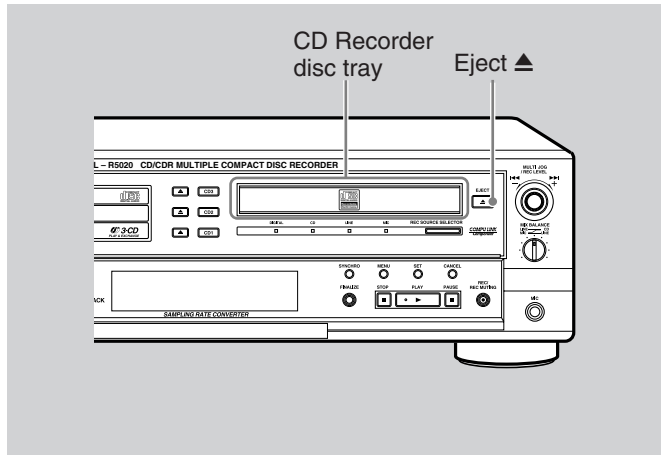

On the unit ONLY:

1 Press EJECT ▲.

The unit automatically turns on and the selected disc tray comes out.

2 Load a disc correctly on the circle of the disc tray, with its label side up.

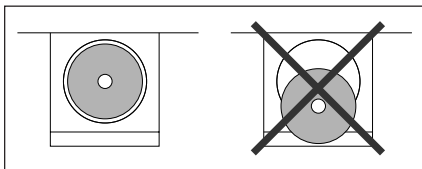
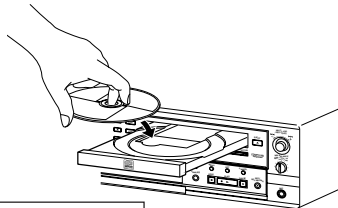

- When using a CD single (8 cm), place it on the inner circle of the disc tray.

3 Press EJECT ▲ again.

The disc tray closes.

- CD Recorder requires a longer read-out time than 3-CD Changer does. This is caused by the fact that CD Recorder needs to read out more disc information.

Playing Back a Disc—Normal Play

On the unit:

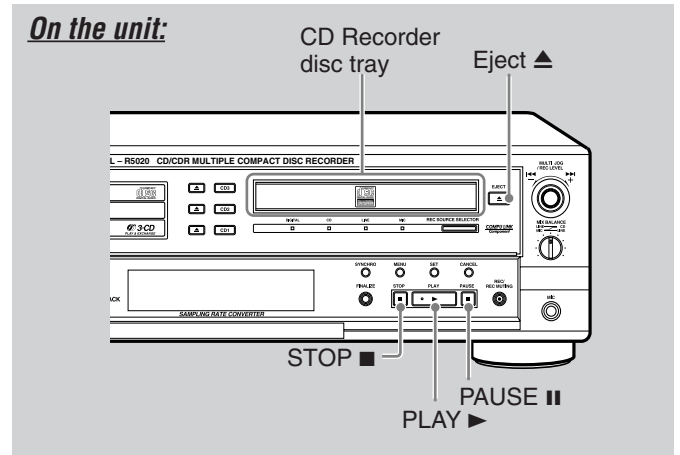

1 Load a disc onto the CD Recorder disc tray (see the left).

2 Press PLAY ▶ for CD Recorder.

The CD RECORDER indicator lights up on the display. CD Recorder reads out the disc contents and the playback starts with the first track.

- CD Recorder stops playing after playing back the loaded disc.

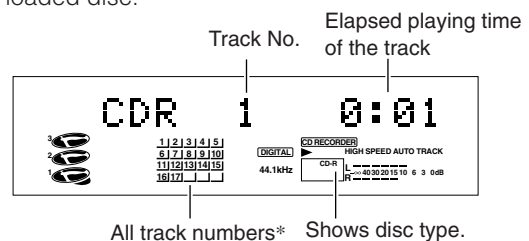

- * Track numbers already played go off from the display. If a disc includes more than 20 tracks, the track numbers exceeding 20 cannot be shown.

To stop playback for a moment, press PAUSE ||. To resume play, press PLAY ▶. The playback starts from where it has been stopped.

To stop playback, press STOP ■.

To remove the disc, press EJECT ▲.

Remote control:

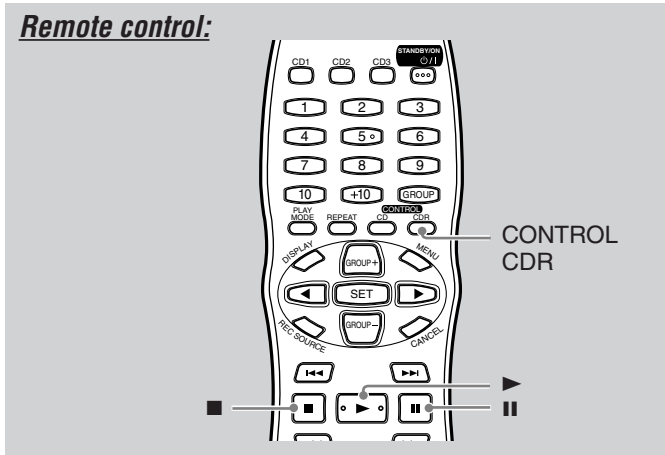

1 Load a disc onto the CD Recorder disc tray (see page 16).

2 Press **CONTROL CDR**, then **▶**.

The CD RECORDER indicator lights up on the display. CD Recorder reads out the disc contents and the playback starts with the first track.

- CD Recorder stops playing after playing back the loaded disc.

To stop playback for a moment, press **||**. To resume play, press **▶**. The playback starts from where it has been stopped.

To stop during playback, press **■**.

Basic Disc Operations

To go to another track

On the unit:

Turn MULTI JOG **▶▶▶** / **◀◀◀**.



From the remote control:

Press **▶▶▶** or **◀◀◀**.

- **▶▶▶**: Skips to the beginning of the next or succeeding tracks.
- **◀◀◀**: Goes back to the beginning of the current or previous tracks.

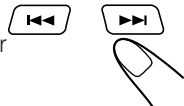

To go to another track directly

From the remote control ONLY:

Select a track number using the number buttons.

Ex.: For track number 5, press 5.

For track number 15, press +10, then 5.

For track number 20, press +10, then 10.

For track number 32, press +10, +10, +10, then 2.

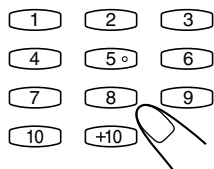

To locate a particular point in a track during play

From the remote control ONLY:

Press and hold **▶▶▶** or **◀◀◀**.

- **▶▶▶**: Fast-forwards the tracks.
- **◀◀◀**: Fast-reverses the tracks.

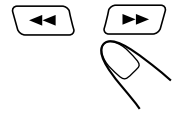

*If you press and hold **▶▶▶** or **◀◀◀** during pause, no sound comes out. When you release your finger from the button, the pause mode will resume.*

Repeating Tracks—Repeat Play

You can repeat playing individual tracks or all tracks in a disc as many times as you like.

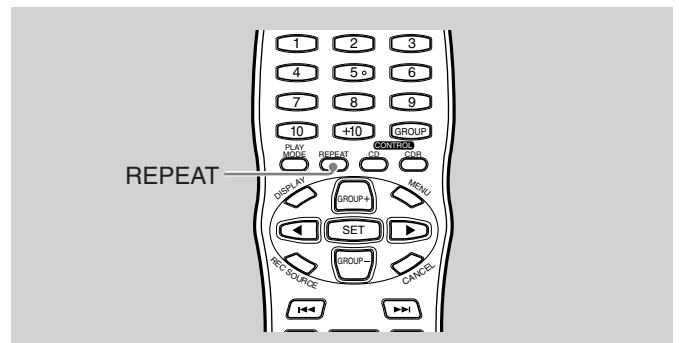

From the remote control ONLY:

Press REPEAT during or before playing.

The REPEAT indicator lights up on the display.

- Each time you press the button, Repeat Play mode changes as follows:



- **REPEAT 1CD**: Repeats all the tracks on the loaded disc.
- **REPEAT 1**: Repeats one track.

To cancel Repeat Play, press REPEAT repeatedly until the REPEAT indicator goes off from the display.

- Ejecting the disc also cancels Repeat Play.

Playing Back MP3 Discs on 3-CD Changer

- You can play back MP3 tracks (files) recorded on MP3 discs (CD-R/CD-RW) on the built-in 3-CD Changer.
- You cannot record MP3 tracks using the built-in CD Recorder.
- Program Play, Random Play and Pitch Control are not available for MP3 discs.

About MP3

MP3 is an abbreviation of Motion Picture Experts Group (or MPEG) Audio Layer 3. MP3 is simply a file format with a data compression ratio of 1:10 (128 kbps*). That means, by using MP3 format, one CD-R or CD-RW can contain 10 times as much data volume as a regular CD can.

* Bit rate is the average number of bits that one second of audio data will consume. The unit used is kbps (1024 bits/second). To get a better audio quality, choose a higher bit rate. The most popular bit rate for encoding and the most recommended for this 3-CD Changer is 128 kbps.

Compatible with ID3v1

Extra information data such as album title, performer name, song title, recording year, music genre and a brief comment can be stored within an MP3 track.

3-CD Changer can show ID3v1 tags (album title, performer name and song title) on the display.

- Some characters cannot be shown correctly.
- 3-CD Changer is not compatible with ID3v2.

Other Main Features in this unit:

- Maximum number of groups (directories)/files (files): 512 (total)
- Available characters for group/track names: A-Z, 0-9, _ (underscore)
- Maximum number of characters for track name (ISO 9660 Level 1): 12 (inclusive of separation mark—“.” and extension code—“mp3”)
(ISO 9660 Level 2): 31 (inclusive of separation mark—“.” and extension code—“mp3”)
- Maximum number of characters for group name: 31



- 3-CD Changer cannot read or play an MP3 track without the extension code—mp3.
- 3-CD Changer can only read MP3 tracks compliant with ISO 9660 Level 1 or Level 2.
- Unfinalized discs cannot be played back.
- “Packet Writing” discs cannot be played back.
- If a disc is recorded with multiple sessions, only the first session can be played back. However if a session is not closed (not finalized), it cannot be played back.

MP3 Disc Structure

MP3 “tracks (files)” can be recorded in “groups (directories)” —in PC terminology.

During recording, the tracks and groups can be arranged in a way similar to arranging files and directories of computer data.

“Root” is similar to the root of a tree. Every track and group can be linked to and be accessed from the root.

Playback order, track search order, and group search order of the MP3 tracks recorded on a disc are determined by the writing (or encoding) application; therefore, playback order may be different from the one you have intended while recording the groups and the tracks.

The illustration below shows an example of how MP3 tracks are recorded on a CD-R or CD-RW, how they are played back, and how they are searched for on this 3-CD Changer.

MP3 group/track configuration

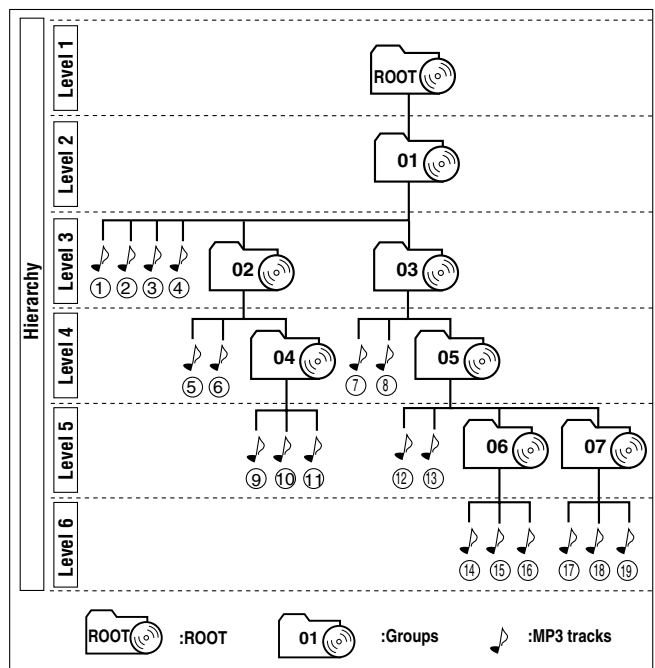

MP3 playback and search order

- The numbers in circles below the MP3 tracks (♪) indicate the playback order and search order of the MP3 tracks. Normally 3-CD Changer plays back MP3 tracks in the recorded order.
- The numbers inside the groups indicate the playback order and search order of the groups on an MP3 disc. Normally 3-CD Changer plays back MP3 tracks in the groups in the recorded order.

Playing Back MP3 Discs

You can play back MP3 discs on 3-CD Changer.

- You can place either an audio CD or an MP3 disc on any disc tray.

IMPORTANT

When using operating buttons (▶, ■, ||) on the remote control for the following operations, check the CD PLAYER (3-CD Changer) indicator lights up on the display. If not, press CONTROL CD to select 3-CD Changer.

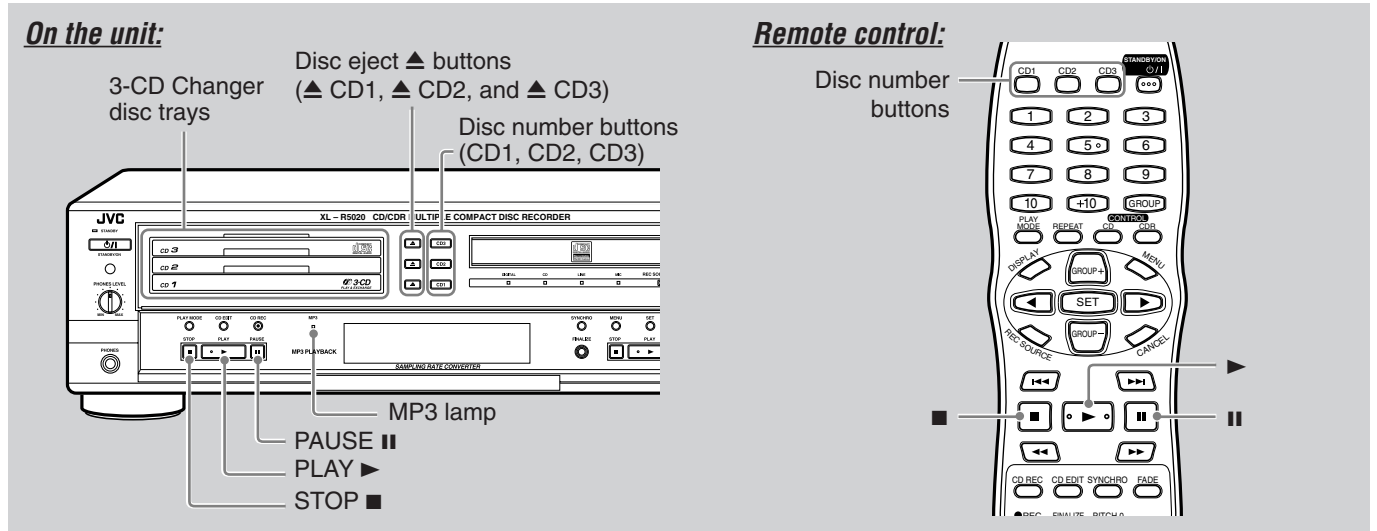

1 Load MP3 discs onto the 3-CD Changer disc trays (see page 10).

2 Press one of the disc number buttons (CD1, CD2 or CD3) you want to play.

The CD PLAYER indicator lights up on the display. When 3-CD Changer reads out the disc contents and detects it as an MP3 disc, the disc information appears on the display as follows. The MP3 lamp on the unit lights up.

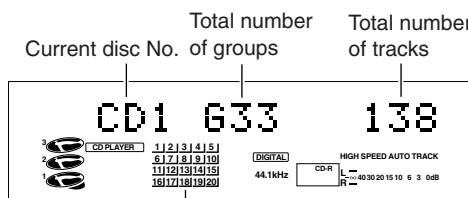

All track numbers included in the selected disc

Playback starts with the first track of the first group. (For playback order of an MP3 disc, see page 18.) The playback information appears on the display as follows.

- If a track has ID3v1 tags, album title, performer name and song title also appear on the display. If not, group (directory) name and track (file) name appear.

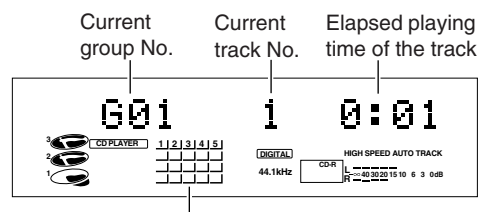

All track numbers included in the currently playing group*

* Track numbers already played go off from the display.

- 3-CD Changer stops after playing back all loaded discs once.
- Pressing PLAY ▶ for 3-CD Changer on the unit, or pressing CD CONTROL then ▶ on the remote control also starts playing back from the disc marked ▲.

To stop playback for a moment, press PAUSE || for 3-CD Changer on the unit or || on the remote control. To resume recording, press PLAY ▶ for 3-CD Changer on the unit or ▶ on the remote control.

To stop playback, press STOP ■ for 3-CD Changer on the unit or ■ on the remote control.

To remove a disc, press the corresponding 3-CD Changer disc eject ▲ button (▲ CD1, ▲ CD2, or ▲ CD3) on the unit.



- MP3 discs may require a longer read-out time (either CD-R or CD-RW). This is due to the complexity of the group/track configuration.
- No signal comes out through the DIGITAL OUT terminals while playing back an MP3 disc.

Basic MP3 Disc Operations

To go to another track

On the unit:

Turn MULTI JOG $\blacktriangleright\blacktriangleright$ / $\blacktriangleleft\blacktriangleleft$.

From the remote control:

Press $\blacktriangleright\blacktriangleright$ or $\blacktriangleleft\blacktriangleleft$.

- $\blacktriangleright\blacktriangleright$: Skips to the beginning of the next or succeeding tracks (beyond the group boundaries).
- $\blacktriangleleft\blacktriangleleft$: Goes back to the beginning of the current or previous tracks (beyond the group boundaries).

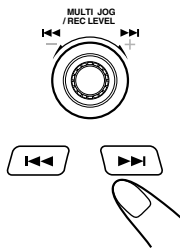

While the last track of the last group is playing, turning MULTI JOG $\blacktriangleright\blacktriangleright$ / $\blacktriangleleft\blacktriangleleft$ on the unit to the right or pressing $\blacktriangleright\blacktriangleright$ on the remote control goes to the first track of the next disc.

To go to another track within a group directly

From the remote control ONLY:

Select a track number using the number buttons.

Ex.: For track number 5, press 5.

For track number 15, press +10, then 5.

For track number 20, press +10, then 10.

For track number 32, press +10 three times, then 2.

For track number 125, press +10 twelve times, then 5.

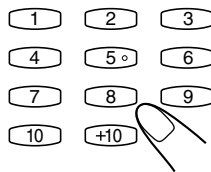

To locate a particular point in a track during play

From the remote control ONLY:

Press and hold $\blacktriangleright\blacktriangleright$ or $\blacktriangleleft\blacktriangleleft$.

- $\blacktriangleright\blacktriangleright$: Fast-forwards the tracks.
- $\blacktriangleleft\blacktriangleleft$: Fast-reverses the tracks.

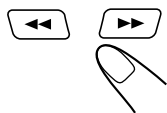

- If you press and hold $\blacktriangleright\blacktriangleright$ or $\blacktriangleleft\blacktriangleleft$ during pause, no sound comes out. When you release your finger from the button, the pause mode will resume.
- Fast-forward and fast-reverse may not be performed smoothly on MP3 discs.

To go to another group

From the remote control ONLY:

Press GROUP + or GROUP -.

- GROUP +: Skips to the beginning of the next groups.
- GROUP -: Goes back to the beginning of the previous groups.

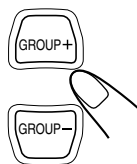

To go to another group directly

From the remote control ONLY:

Press GROUP, then select a group number by pressing the number buttons.

Ex.: For group number 5, press 5.

For group number 15, press +10, then 5.

For group number 32, press +10 three times, then 2.



To change the display information

You can change the information on the display.

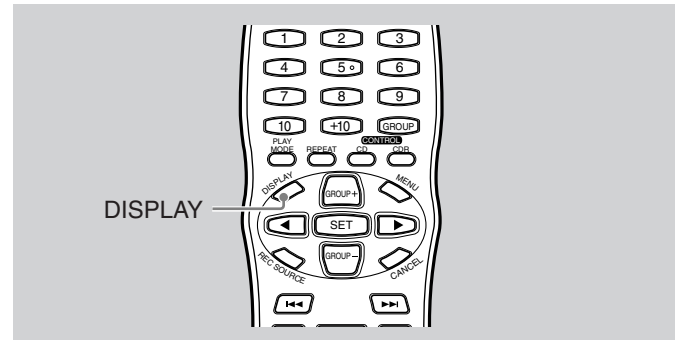

From the remote control ONLY:

Press DISPLAY while playing.

The display shows album title, performer name and song title (or group name and track name appear) for about 3 seconds.

Tracks with ID3v1 tags

Group No., track No. and elapsed track playing time ↔ Album title, performer name and song title

Tracks without ID3v1 tags

Group No., track No. and elapsed track playing time ↔ Group name and track name

Repeating Tracks—Repeat Play

You can repeat playing individual tracks or all tracks in a disc as many times as you like.

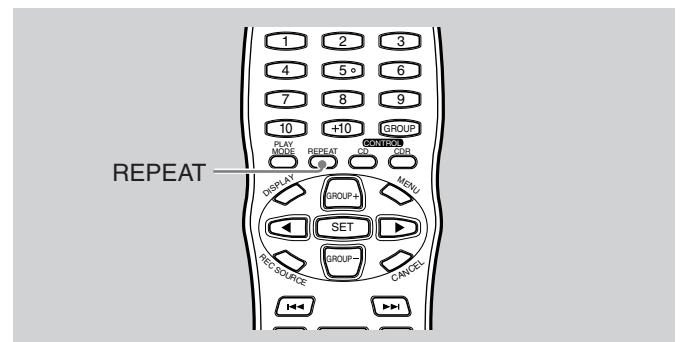

From the remote control ONLY:

Press REPEAT repeatedly during or before playing.

The REPEAT indicator lights up on the display.

- Each time you press the button, Repeat Play changes as follows:

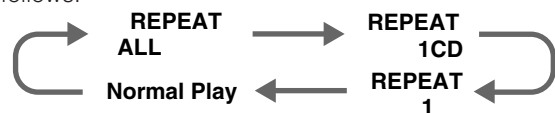

- REPEAT ALL: Repeats all tracks on all the loaded discs.
- REPEAT 1CD: Repeats all the tracks on one disc.
- REPEAT 1: Repeats one track.

To cancel Repeat Play, press REPEAT repeatedly until the REPEAT indicator goes off from the display.

- Ejecting the current playing disc also cancels Repeat Play.

Recording on a CD-R/CD-RW

Before You Start Recording

Before you start, remember...

- Perform recording onto a CD-R AUDIO or CD-RW AUDIO disc (see page 3).
- When you record onto a partially recorded unfinalized CD-R or CD-RW, its contents are not erased or overwritten. The recording starts from the point following the last recorded track of the disc.
For CD-RW only: If you want to record on such a CD-RW from the beginning, you have to erase its contents first (see “Erasing all tracks (only for CD-RW)—Disc Erase” on page 36). (You cannot erase the contents recorded on a CD-R.)
- You can record up to 99 tracks on a CD-R or CD-RW. When the data recordable memory area of a CD-R or CD-RW becomes full while recording, recording will stop automatically.
- If PCA (Power Calibration Area) or PMA (Program Memory Area) of the disc is recorded fully, recording cannot be performed on this disc even though there are still unused memory spaces on it.
- Before recording on a CD-R, it is recommended to make a test recording on a CD-RW.
- You cannot perform digital-recording from the digitally recorded CD-R or CD-RW because only the first generation digital copy is allowed; This is to protect copyrights (see page 42).



- *CD Recorder automatically selects appropriate recording—either digital or analog—during CD Synchronized Recording. When digital source is selected as the playback sound, it will be recorded digitally if it is a first-generation digital copy (see page 42). If not, CD Recorder selects analog recording.*
- *MP3 files cannot be recorded on this CD Recorder. If you are going to record MP3 files on CD Recorder, “CANNOT REC” appears on the display.*
- *Before recording, finalizing, or adding track skip marks, make sure that all the disc trays are closed. You cannot open any disc tray while these operations are done.*

Available recording methods

This CD Recorder provides a variety of the recording methods.

You can select and use the following recording methods according to the playback source.

■ Recording from any source

—Standard Recording:

- Standard Recording—see page 22.

■ Recording from 3-CD Changer

—CD Synchronized Recording:

- Disc Direct Recording—see page 26.
- One Track Recording—see page 28.
- Listening Edit Recording—see page 29.
- Program Edit Recording—see page 30.

■ Recording from external components

- Sound Synchronized Recording—see page 31.
- Sound Mixing Recording—see page 32.

Connecting a microphone

You can record your voice through MIC jack on the unit. When using a microphone, connect a microphone with a standard 6.3 mm plug.

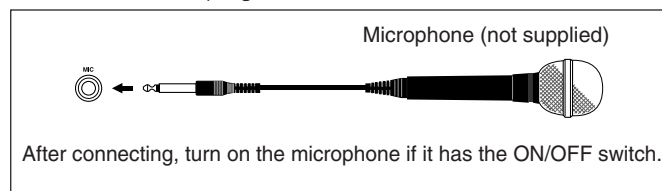

Finalization

This is the final process in recording on a CD-R or CD-RW. “Finalizing a disc” means writing the TOC (Table of Contents) on the recorded disc.

Only after this process is completed, a recorded CD-R or CD-RW can be played back on a CD player compatible with CD-R/CD-RW. It is also recommended to finalize a disc before playing back on this 3-CD Changer.

CD-R : You cannot add any track after finalizing.

CD-RW : You can add tracks after finalizing by unfinalizing the disc (see page 34).

About track-marking

Whenever you turn on the unit, auto track-marking is activated. (The AUTO TRACK indicator lights up on the display.)

When auto track-marking is activated

- Recording from 3-CD Changer (CD DIGITAL, CD ANALOG):
Track marks are recorded automatically at the points where the tracks change.
- Recording from an external component connected to the LINE IN and MIC jacks (LINE IN, MIC IN, CD+LINE MIX, CD+MIC MIX, LINE+MIC MIX):
If there is a blank of 4 seconds or more, CD Recorder will consider it as a blank separating 2 tracks and consequently put a track mark.
- Recording through the DIGITAL IN terminals (OPTICAL IN, COAXIAL IN):
—If the playback source is an MD recorder, CD player or DAT deck, they are recorded automatically at the points where the tracks change.
—If the playback source is other than above, this unit functions in the same way for recording an analog source.

To cancel auto track-marking and use manual track-marking, see “Recording track marks manually” on page 34.

Recording Manually—Standard Recording

You can use this method to record any sources and to record any combination of two sources.

IMPORTANT

When using operating buttons (▶, ■, ||) on the remote control, check which indicator lights up on the display—CD PLAYER (3-CD Changer) or CD RECORDER. If the incorrect indicator is lit, press CONTROL CD or CONTROL CDR to select the correct target source.

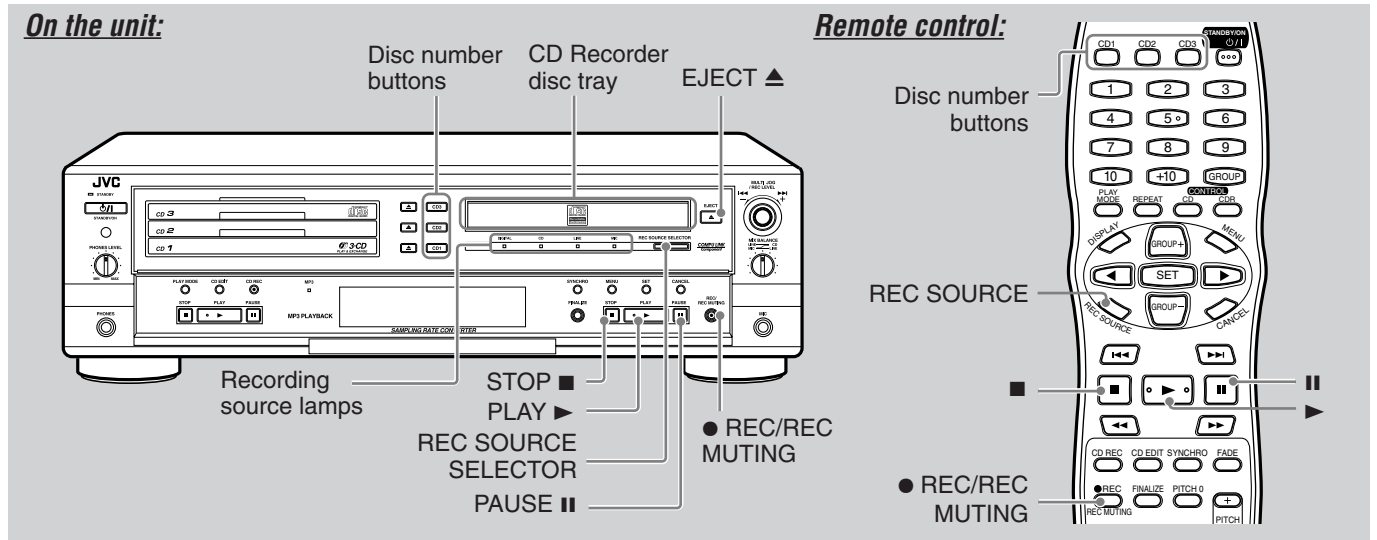

1 Load a recordable CD-R or CD-RW onto the CD Recorder disc tray.

2 Press REC SOURCE SELECTOR on the unit or REC SOURCE on the remote control to select a source to record from.

Selected recording source lamp on the unit lights up.

- Each time you press the button, the following recording sources appear:

- OPTICAL IN** :Records through the DIGITAL IN/OPTICAL terminal (digital recording). The DIGITAL lamp lights up.
- COAXIAL IN** :Records through the DIGITAL IN/COAXIAL terminal (digital recording). The DIGITAL lamp lights up.
- CD DIGITAL** :Records from 3-CD Changer (digital recording). The CD lamp lights up. Prepare discs on the 3-CD Changer disc trays.
- CD ANALOG** :Records from 3-CD Changer (analog recording). The CD lamp lights up. Prepare discs on the 3-CD Changer disc trays.
- LINE IN** :Records through the LINE IN (REC) jacks (analog recording). The LINE lamp lights up.
- MIC IN** :Records through the MIC jack (analog recording). The MIC lamp lights up.
- CD+LINE MIX** :See page 32.
- CD+MIC MIX** :See page 32.
- LINE+MIC MIX** :See page 32.

3 Press ● REC/REC MUTING.

The unit enters recording pause. The remaining time of CD-R or CD-RW is shown on the display. The || and REC indicators light up on the display.

- If OPC (see page 42) is being performed, "UPDATE OPC" flashes on the display.

Paying time of 1st track Signal type (analog or digital) CD-R or CD-RW remaining time

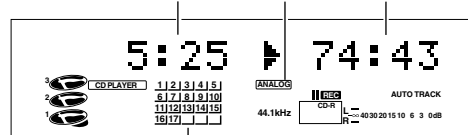

All track numbers of the selected disc

EX.: When selecting "CD ANALOG" as a recording source.

4 Adjust the recording level when recording from an external component connected to the LINE IN and MIC jacks (see page 23 for details).

- Recording level adjustment is stored until you change the recording source.

5 Start recording.

When recording from 3-CD Changer:

1) Press PLAY ▶ for CD Recorder on the unit or ▶ on the remote control.

Recording starts. The ▶ and REC indicators light up on the display.

- Pressing ● REC/REC MUTING also starts recording.

2) Press one of the disc number buttons (CD1, CD2, CD3) you want.

When recording from another source:

1) Press PLAY ▶ for CD Recorder on the unit or ▶ on the remote control.

Recording starts. The ▶ and REC indicators light up on the display.

- Pressing ● REC/REC MUTING also starts recording.

2) Start playback of the external components.

To stop recording for a moment, press PAUSE **||** for CD Recorder on the unit or **||** on the remote control. To resume recording, press PLAY **▶** for CD Recorder on the unit or **▶** on the remote control. (A track mark is recorded when you resume recording.)

To stop recording, press STOP **■** for CD Recorder on the unit or **■** on the remote control.

To eject the disc, press EJECT **▲**.

“FINALIZE ?” appears on the display.

—To finalize, press FINALIZE or SET. After finalizing, the disc is ejected.

—Not to finalize, press EJECT **▲** again or wait for 5 seconds so that the disc comes out without being finalized.



- If “UNLOCK” appears on the display when selecting “OPTICAL IN” or “COAXIAL IN,” digital component connected to the DIGITAL IN terminals is not recognized. Check the connection (see page 8).
- When selecting “CD DIGITAL” as the recording source with Pitch Control activated (see page 15), the recording source is automatically changed to “CD ANALOG.”

To adjust the analog recording level

You can adjust the recording level when recording from an external component connected to the LINE IN jacks.

- When you record through the microphone, you can also adjust the recording level.

1 While CD Recorder is in recording pause mode (or recording), press MENU.

2 Turn REC LEVEL +/- control on the unit or press ▶ or ◀ on the remote control to adjust the recording level.

- Adjust the recording level so that the OVER indicator never lights. If the OVER indicator lights up in red intermittently, the recorded sound will be distorted.

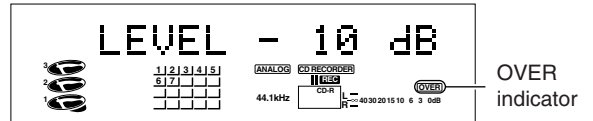

- You can adjust the recording level within the range of -68 dB to +12 dB. Normally set it to 0 dB (initial setting).

3 Press SET or MENU to finish the adjustment.

- Recording level adjustment is stored until the recording source is changed.



When you unplug the AC power cord or if a power failure occurs recording level adjustment will be erased. If this happens, adjust the recording level again.

On the unit:

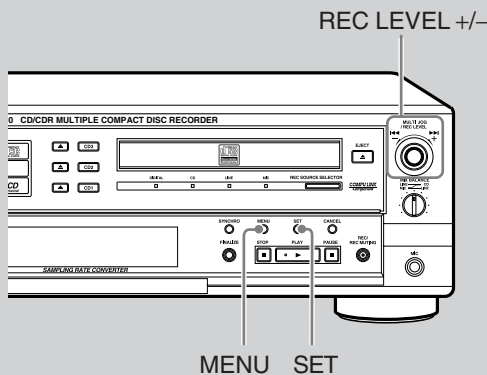

Remote control:

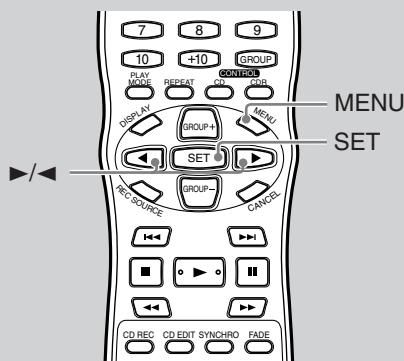

To fade in and out recording—only for analog source

You can fade in and fade out the for about 5 seconds when recording analog source is either “LINE IN,” “MIC IN,” “CD+LINE MIX,” “CD+MIC MIX” or “LINE+MIC MIX.”

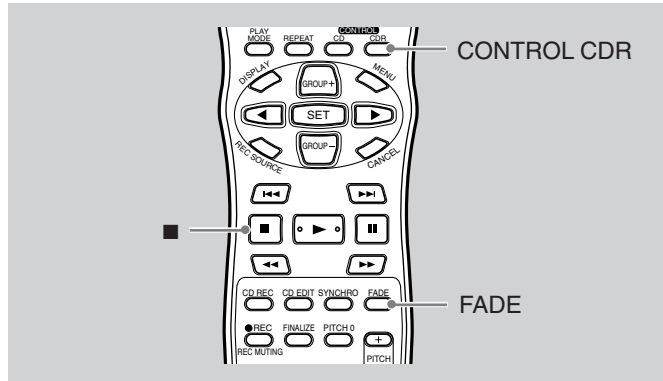

From the remote control ONLY:

To start recording by fading in—press FADE when the unit is in recording pause mode.

The FADER indicator lights up for a while.

To finish recording by fading out—press FADE while the unit is recording.

The FADER indicator lights up for a while.

- The unit enters recording pause after fading out.

To stop recording, press CONTROL CDR, then ■.

To change the display information while recording

You can change the information on the main display.

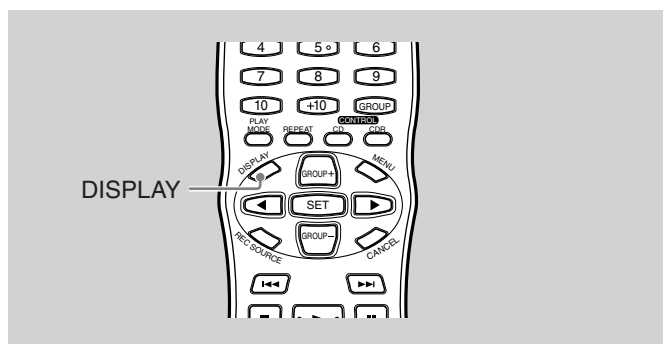

From the remote control ONLY:

Press DISPLAY to change the display information.

The display changes to show track information for 3 seconds as follows:

■ When the recording source is 3-CD Changer

15:21 ▶ 24:43 ◀▶ CD1 1▶CDR 1

Elapsed playing time of current track CDR remaining time Current disc & track no. Current CDR track no.

■ When the recording source is other than 3-CD Changer

CDR REM 64:43 ◀▶ LINE >CDR 3

CDR remaining time Recording source Current CDR track no.

Ex.: When “LINE IN” is selected as a recording source.

To make a silent portion while recording

You can record a 4-second silence when using Standard Recording.

On the unit:

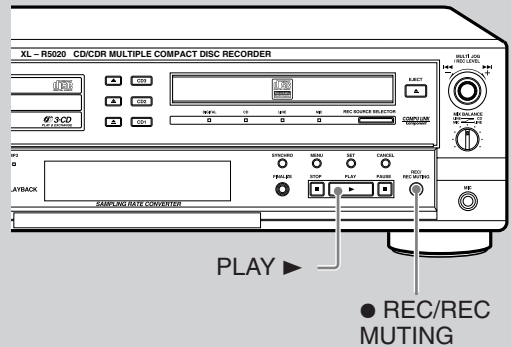

Remote control:

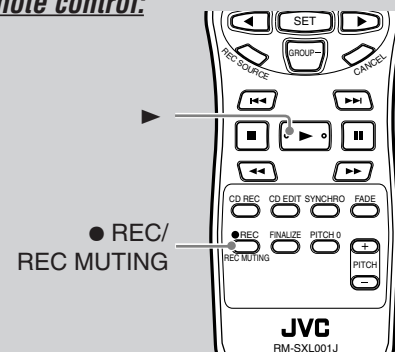

Press ● REC/REC MUTING while recording to make a silent portion.

Recording enters recording pause after recording a 4-second silence.

- You can also make a silent portion as long as you want by holding the button.

To resume recording, press PLAY ▶ for CD Recorder on the unit or ▶ on the remote control. (A track mark is recorded when you resume recording.)

Preparing for CD Synchronized Recording

The following four methods are available when recording from discs in 3-CD Changer onto a CD-R or CD-RW in CD Recorder.

Disc Direct Recording—Records a disc in 3-CD Changer (see page 26).

One Track Recording—Records a track of a disc in 3-CD Changer (see page 28).

Listening Edit Recording—Records only tracks you select while playing back discs in 3-CD Changer (see page 29).

Program Edit Recording—Records tracks you program from discs in 3-CD Changer (see page 30).

When using these CD Synchronized Recording, you can set the following settings before recording if necessary.

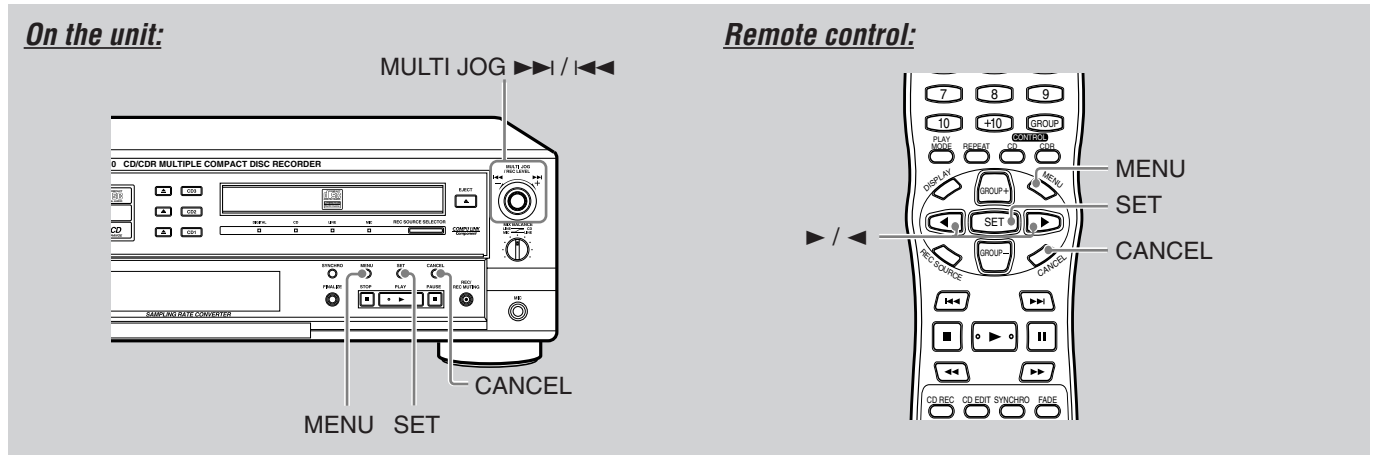

■ Changing the recording speed

The speed of digital recording on a CD-R and CD-RW is initially set to high speed—4 times normal speed for CD-Rs and 2 times for CD-RWs. (The HIGH SPEED indicator lights up on the display.) You cannot listen playback sound while recording. To change the setting to normal speed follow the procedure below.

- When analog recording is performed, the recording speed is fixed to normal speed.

Available recording methods

Disc Direct Recording, One Track Recording, Listening Edit Recording, Program Edit Recording

- 1** While 3-CD Changer and CD Recorder are in stop mode, press MENU.
- 2** Turn MULTI JOG ►►► / ◀◀◀ on the unit or press ► or ◀ on the remote control until “DUB-SPEED” appears on the display, then press SET.
“SPEED HIGH” (initial setting) appears on the display.
 - To cancel the setting, press CANCEL.
- 3** Turn MULTI JOG ►►► / ◀◀◀ on the unit or press ► or ◀ on the remote control to select “SPEED 1X,” then press SET.

To set to the high speed again, select “SPEED HIGH” in step 3. The HIGH SPEED indicator lights up on the display.

■ Finalizing discs automatically

CD-R and CD-RW are not finalized automatically when performing Listening Edit Recording and Program Edit Recording, since they are expected further additional recordings. To finalize a disc automatically after these recordings are performed, follow the procedure below.

Available recording methods

Disc Direct Recording, Listening Edit Recording, Program Edit Recording

- 1** While 3-CD Changer and CD Recorder are in stop mode, press MENU.
- 2** Turn MULTI JOG ►►► / ◀◀◀ on the unit or press ► or ◀ on the remote control until “AUTO FINALIZE” appears on the display, then press SET.
“FINALIZE OFF” (initial setting) appears on the display.
 - To cancel the setting, press CANCEL.
- 3** Turn MULTI JOG ►►► / ◀◀◀ on the unit or press ► or ◀ on the remote control to select “FINALIZE ON,” then press SET.

How this function actually works?

When you start one of the recording methods—Disc Direct Recording, Listening Edit Recording and Program Edit Recording, “ADD FINALIZE?” appears.

—To finalize the disc after recording is done, press SET.

—Not to finalize the disc, press CANCEL.

- If you do not press any button within 5 seconds, recording will start automatically. After recording is over, the disc will be finalized.

To turn off the automatic finalization, select “FINALIZE OFF” in step 3.



Finalization is not performed when the recording is stopped manually.

Recording from 3-CD Changer—CD Synchronized Recording

Using the synchronized recording methods, you can start playback and record at the same time.

- CD Recorder automatically selects appropriate recording—either digital or analog—during CD Synchronized Recording. When digital source is selected as the playback sound, it will be recorded digitally only if it is a first-generation digital copy (see page 42).
- Initial setting of digital recording speed on CD-R is 4 times normal speed and 2 times for CD-RW, so that no sound is heard while recording. To change the recording speed, see page 25.

IMPORTANT

When using operating buttons (▶, ■, II) on the remote control, check which indicator lights up on the display—CD PLAYER (3-CD Changer) or CD RECORDER. If the incorrect indicator is lit, press CONTROL CD or CONTROL CDR to select the correct target source.

■ Disc Direct Recording

Synchronized Disc Direct Recording allows you to easily record a disc in 3-CD Changer onto a CD-R or CD-RW in CD Recorder.

On the unit:

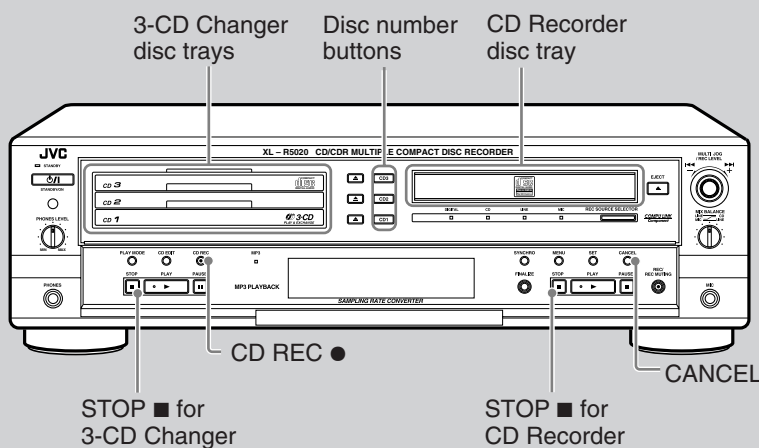

Remote control:

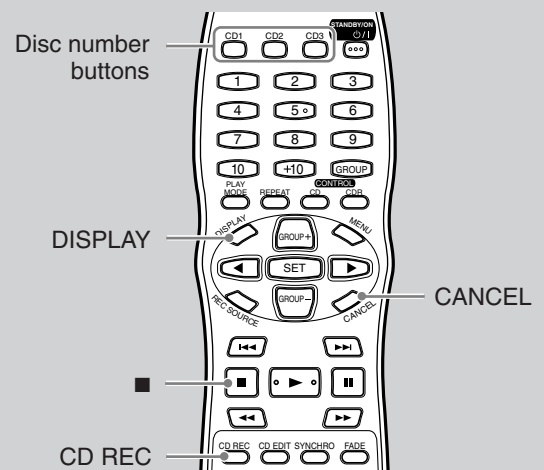

1 Load discs onto the 3-CD Changer disc trays and a recordable CD-R or CD-RW onto the CD Recorder disc tray.

2 Select the disc number you want to record from.

1) Press one of the disc number buttons (CD1, CD2 or CD3).

Playback starts.

2) Press STOP ■ to stop playback.

3 Press CD REC (●) to start recording.

- If OPC (see page 42) is being performed, "UPDATE OPC" flashes on the display before starting.
- If "AUTO FINALIZE" is set to "FINALIZE ON," "ADD FINALIZE?" appears on the Display.
 - To finalize after recording automatically, press SET.
 - Not to finalize, press CANCEL (see page 25).

"DISC DUBBING" appears on the display and 3-CD Changer starts playing and CD Recorder starts recording at the same time. The SYNCHRO and CD REC 1CD indicators light up on the display.

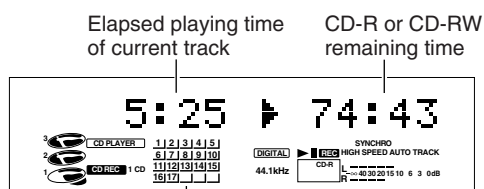

All track numbers of the selected disc

Recording stops when the selected disc is recorded, then "STOP DUBBING" flashes on the display for a while.

To stop recording during play, press STOP ■ either for 3-CD Changer or CD Recorder on the unit, or ■ on the remote control. "STOP DUBBING" flashes on the display for a while.

- Even though "AUTO FINALIZE" is set to "FINALIZE ON," Finalization is not performed automatically when you stop recording manually.

To check the current track number during play, press DISPLAY on the remote control. The currently played track number appears for 3 seconds (see page 24).



- If "SHORT REMAIN" appears, there is not enough remaining time left on a CD-R or CD-RW and the recording does not start. Eject and change the disc. To start recording on the disc, press CD REC (●) again.
- Repeat Play is canceled temporarily during Disc Direct Recording.

Recording the entire disc without any interruption

When recording from a disc to another disc, the contents of the original disc are duplicated usually track by track. This means if some sounds are recorded between the tracks, they will not be recorded on a newly duplicated disc.

For example, when you play a live disc, you may hear audience clapping their hands; however, these sounds are usually recorded between the tracks so they cannot be recorded. If you want to record these sounds between the tracks on a newly duplicated disc, follow the procedure below.

- This function is only available for Disc Direct Recording.

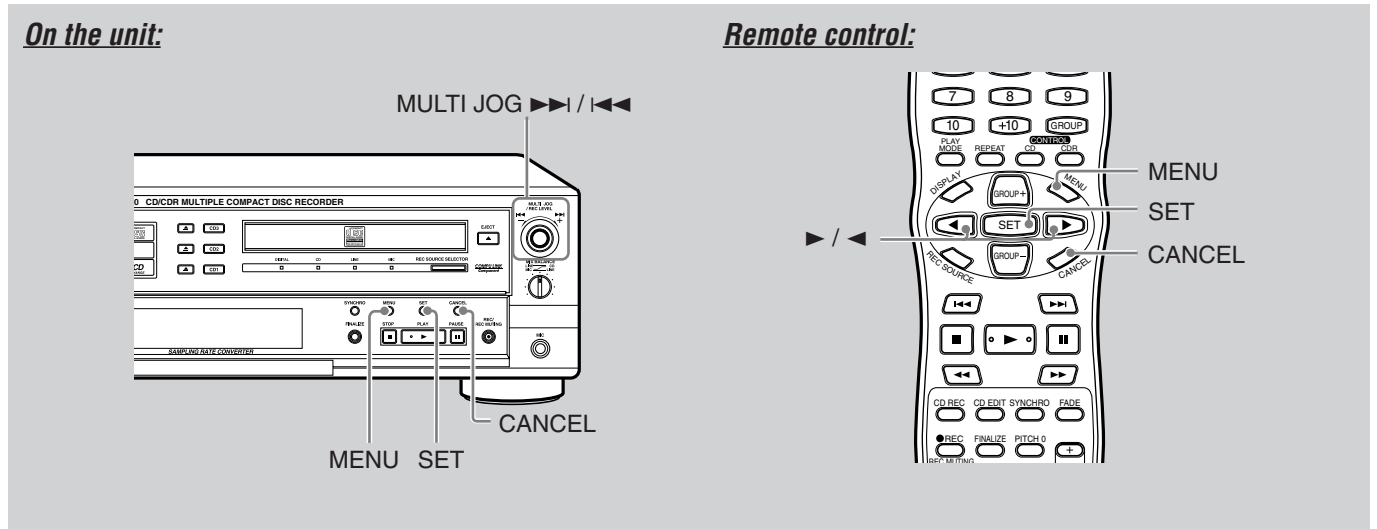

1 While 3-CD Changer and CD Recorder are in stop mode, press MENU.

2 Turn MULTI JOG $\blacktriangleright\blacktriangleright\blacktriangleright$ / $\blacktriangleleft\blacktriangleleft\blacktriangleleft$ on the unit or press \blacktriangleright or \blacktriangleleft on the remote control until "DISC DUB MODE" appears on the display, then press SET. "NORMAL" (initial setting) appears on the display.

- To cancel the setting, press CANCEL.

3 Turn MULTI JOG $\blacktriangleright\blacktriangleright\blacktriangleright$ / $\blacktriangleleft\blacktriangleleft\blacktriangleleft$ on the unit or press \blacktriangleright or \blacktriangleleft on the remote control to select "DUB SEAMLESS," then press SET.

To release the seamless recording, select "NORMAL" in step 3.



You cannot record from a disc restricted by SCMS (see page 42). If the unit detects such a disc, "SCMS PROTECT" appears on the display and the recording will be stopped.

■ One Track Recording

Synchronized One Track Recording allows you to record a track of a disc in 3-CD Changer onto a CD-R or CD-RW in CD Recorder. This recording method is convenient to make a disc of your best albums.

IMPORTANT

When using operating buttons (▶, ■, II) on the remote control, check which indicator lights up on the display—CD PLAYER (3-CD Changer) or CD RECORDER. If the incorrect indicator is lit, press CONTROL CD or CONTROL CDR to select the correct target source.

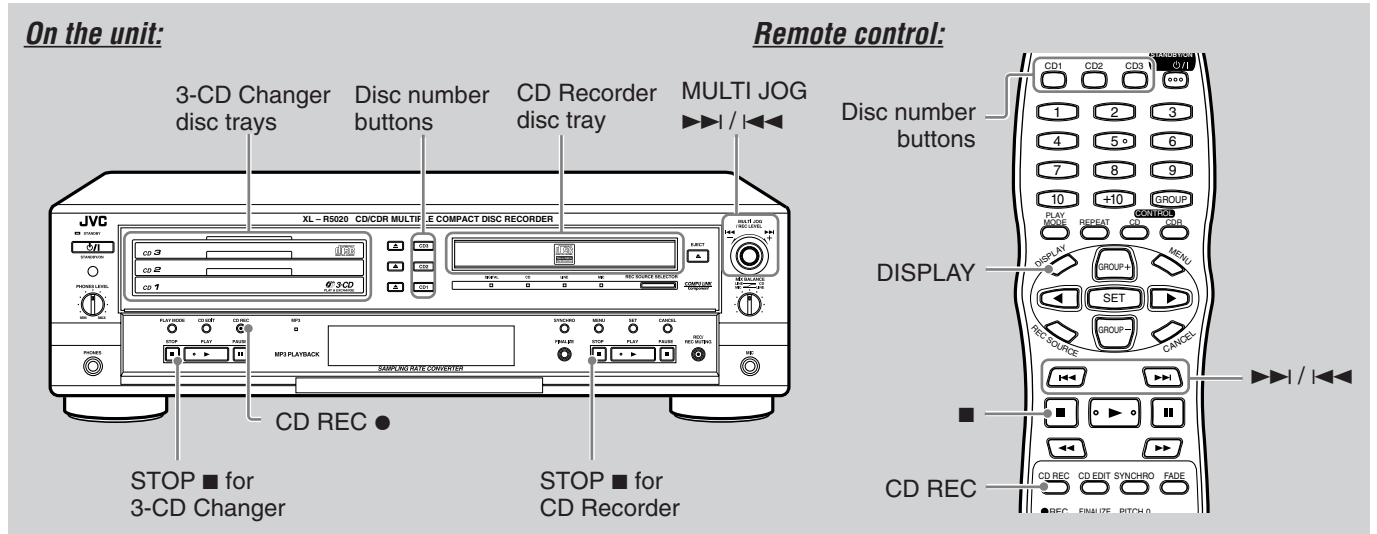

1 Load discs onto the 3-CD Changer disc trays and a recordable CD-R or CD-RW onto the CD Recorder disc tray.

2 Start playing a track you want to record.

- 1) Press one of the disc number buttons (CD1, CD2 or CD3) you want to record from.
- 2) Press the number button(s) on the remote control to select the track you want to record.
 - You can also use MULTI JOG ▶▶/◀◀ on the unit or ▶▶/◀◀ on the remote control to select a track.

3 Press CD REC (●) while playing back a track you want to record.

“1TR DUBBING” appears on the display. Playback of the track is stopped, and the same track starts playing from the beginning again. This time CD Recorder starts recording the track. The SYNCHRO, CD REC 1 indicators light up on the display.

- If OPC (see page 42) is being performed, “UPDATE OPC” flashes on the display before starting.

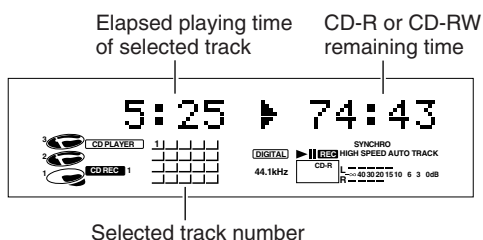

Recording stops when the selected track is recorded, then “STOP DUBBING” flashes on the display for a while.

To stop recording during play, press STOP ■ either for 3-CD Changer or CD Recorder on the unit, or ■ on the remote control. “STOP DUBBING” flashes on the display for a while.

To check the current track number during play, press DISPLAY on the remote control. The currently played track number appears for 3 seconds (see page 24).



- If “SHORT REMAIN” appears on the display, there is not enough remaining time left on a CD-R or CD-RW and the recording does not start. Eject and change the disc. To start recording on the disc, press CD REC (●) again.
- Repeat Play is canceled temporarily during One Track Recording.

■ Listening Edit Recording

Listening Edit Recording allows you to make a program while listening to and checking each track of the loaded discs (up to 3 discs) in 3-CD Changer, then to start recording the program.

- You can program up to **32** tracks.

IMPORTANT

When using operating buttons (▶, ■, II) on the remote control, check which indicator lights up on the display—CD PLAYER (3-CD Changer) or CD RECORDER. If the incorrect indicator is lit, press CONTROL CD or CONTROL CDR to select the correct target source.

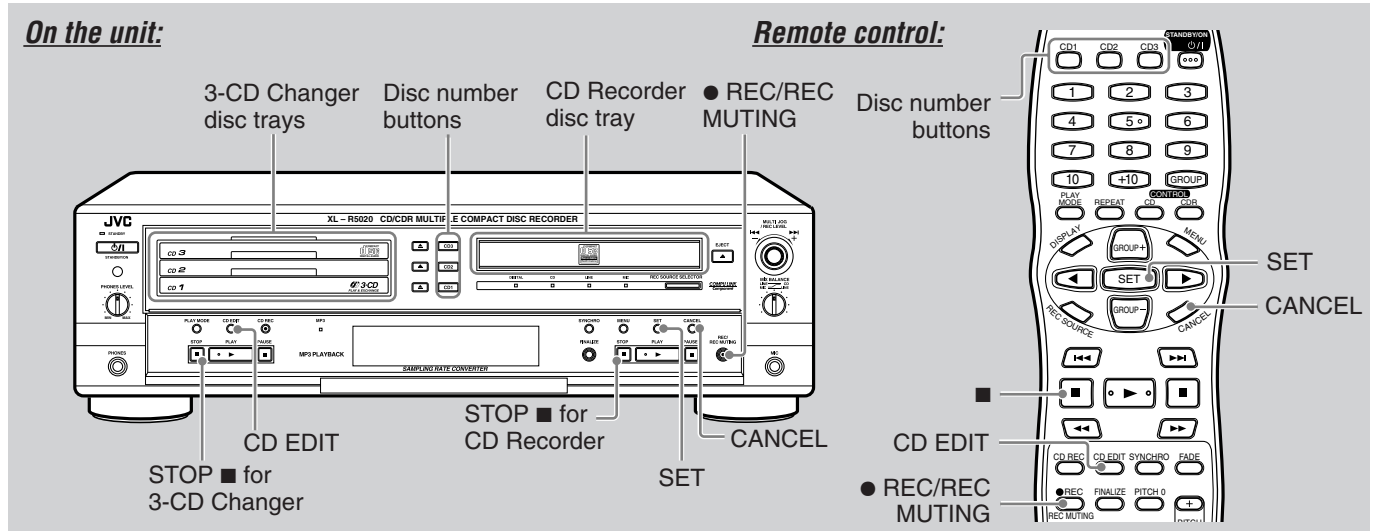

1 Load discs onto the 3-CD Changer disc trays and a recordable CD-R or CD-RW onto the CD Recorder disc tray.

2 Select a disc number you want to record from.

1) Press one of the disc number buttons (CD1, CD2 or CD3).

Playback starts.

2) Press STOP ■ to stop playback.

3 Press CD EDIT once to select "LISTEN EDIT."

The LISTENING EDIT indicator lights up on the display and the first track of the selected disc starts playing.

- If a program has been memorized, the stored program is called up. "LAST L-PG OK?" appears on the display.
 - To record the previously edit program, press SET.
 - To record a newly edit program, press CANCEL.

4 Decide if you want to include the current track in the program or to skip it.

- **To include the currently playing track in the program, press SET.**
The track is programed and the next track starts playing. After the last track of a disc is programed, the first track of the next disc starts playing.
- **To skip the currently playing track, press CANCEL.**
The currently playing track is not programed and the next track starts playing.

If you do not press either button, the currently playing track is not add to the program.

5 To program other tracks, repeat step 4.

- When 32 tracks are programed or after listening through all the tracks, "START TO DUB?" appears on the display.

6 Press ● REC/REC MUTING to start recording.

The tracks are recorded in the order you have programed.

- If OPC (see page 42) is being performed, "UPDATE OPC" flashes on the display before starting.
- If "AUTO FINALIZE" is set to "FINALIZE ON," "ADD FINALIZE?" appears on the Display.
 - To finalize after recording automatically, press SET.
 - Not to finalize, press CANCEL (see page 25).

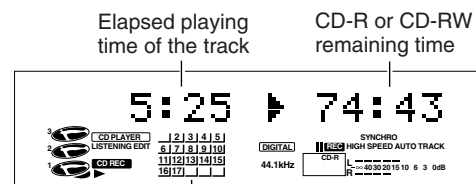

Track numbers already played are erased.

Recording stops when programed tracks are recorded. "STOP DUBBING" flashes on the display for a while.

To stop recording during play, press STOP ■ either for 3-CD Changer or CD Recorder on the unit, or ■ on the remote control. "STOP DUBBING" flashes on the display for a while.

- Even though "AUTO FINALIZE" is set to "FINALIZE ON," Finalization is not performed automatically when you stop recording manually.

To erase all programed tracks, press CANCEL in step 4.

- The program you have made is also erased:
 - when unplugging the AC power cord.
 - when ejecting the currently selected disc tray.



- "▶ NO REM" appears for tracks which cannot be recorded because there is not enough remaining time left on a CD-R or CD-RW. Even though, you can record by pressing ● REC/REC MUTING ("SHORT REM" appears on the display), then SET. The tracks indicated "▶ NO REM" are not recorded.
- Repeat Play is canceled temporarily during Listening Edit Recording.

■ Program Edit Recording

You can arrange the recording order of tracks of the discs in 3-CD Changer before you start playing.

- You can program up to **32** tracks.

IMPORTANT

When using operating buttons (▶, ■, II) on the remote control, check which indicator lights up on the display—CD PLAYER (3-CD Changer) or CD RECORDER. If the incorrect indicator is lit, press CONTROL CD or CONTROL CDR to select the correct target source.

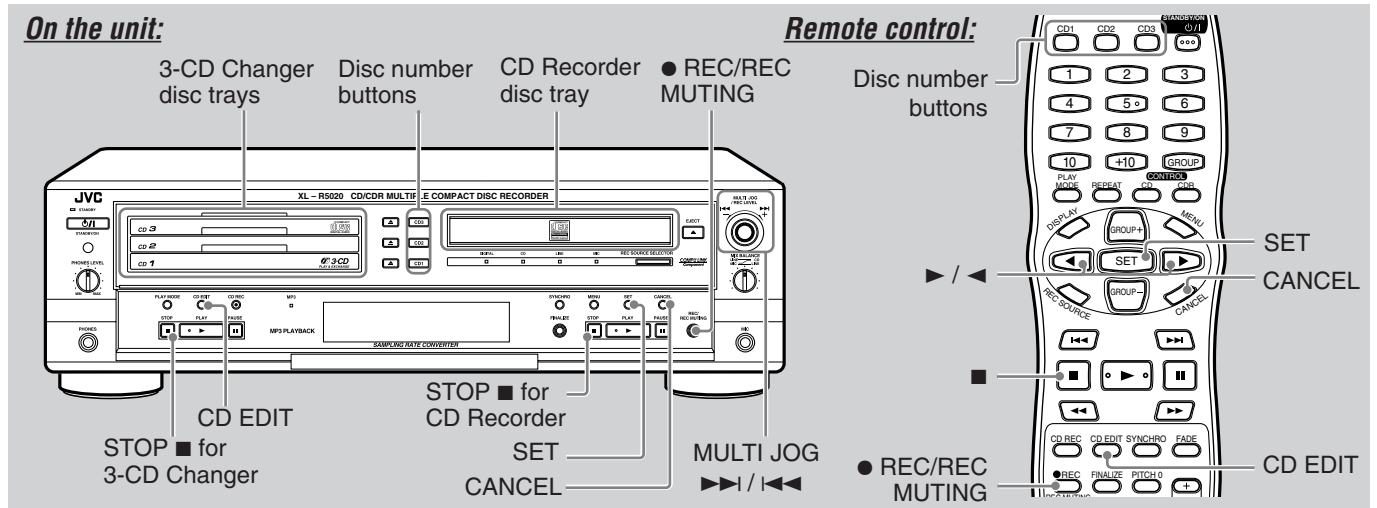

1 Load discs onto the 3-CD Changer disc trays and a recordable CD-R or CD-RW onto the CD Recorder disc tray.

2 Select a disc number you want to recorded from.

1) Press one of the disc number buttons (CD1, CD2 or CD3).

Playback starts.

2) Press STOP ■ to stop playback.

3 Press CD EDIT twice to select "PROGRAM EDIT."

The PROGRAM EDIT indicator lights up on the display and the disc number position flashes.

- If a program has been memorized, it is called up. "LAST P-PG OK?" appears on the display.
 - To record the previously edit program, press SET.
 - To record a newly edit program, press CANCEL.

4 Select a disc number you want to program.

On the unit:

Turn MULTI JOG ▶▶/◀◀, then SET.

From the remote control:

Press ▶ or ◀, then SET

The track number position flashes.

- You can also select a disc number by pressing one of the disc number buttons (CD1, CD2, CD3). When using these buttons, you do not have to press SET.

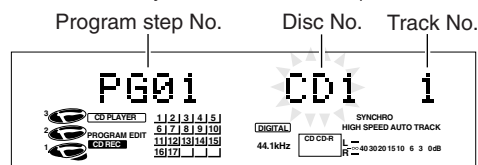

5 Select a track number you want to program.

On the unit:

Turn MULTI JOG ▶▶/◀◀, then SET.

From the remote control:

Press ▶ or ◀, then SET.

- You can also select a track number by using the number buttons on the remote control. When using the number buttons, you do not have to press SET.

6 To program other tracks, repeat steps 4 and 5.

If you program exceeding the remaining time on a CD-R or CD-RW, "CDR NO REM" appears on the display.

- When 32 steps are programmed, "START TO DUB?" appears on the display.

7 Press ● REC/REC MUTING after you have programed all the tracks you want.

- If OPC (see page 42) is being performed, "UPDATE OPC" flashes on the display before starting.
- If "AUTO FINALIZE" is set to "FINALIZE ON," "ADD FINALIZE?" appears on the Display.
 - To finalize after recording automatically press SET.
 - Not to finalize, press CANCEL (see page 25).

The tracks are recorded in the order you have programed. Playback stops when all the programed tracks are recorded. "STOP DUBBING" flashes on the display for a while.

To stop during recording, press STOP ■ either for

3-CD Changer or CD Recorder on the unit, or ■ on the remote control. "STOP DUBBING" flashes on the display for a while.

- Even though "AUTO FINALIZE" is set to "FINALIZE ON," Finalization is not performed automatically when you stop recording manually.

To erase the program, press CANCEL in step 3.

- The program you have made is also erased:
 - when unplugging the AC power cord.
 - when ejecting the currently selected disc tray.



- "CD NO REM" appears for tracks which cannot be recorded because there is not enough remaining time left on a CD-R or CD-RW. Even though, you can record by pressing ● REC/REC MUTING ("SHORT REM" appears on the display), then SET. The tracks indicated "CD NO REM" are not recorded.
- If you have tried to program a track from an empty tray, or a track number that does not exist on the disc (for example, selecting track 14 on a disc that only has 12 tracks), such entries are ignored.
- MP3 disc cannot be played back even though they can be programmed. If this unit detects an MP3 disc, the playback will stop. ("CANNOT REC" appears on the display.)
- You cannot confirm the programed contents or order even though you turn MULTI JOG ▶▶/◀◀ on the unit or press ▶ or ◀ on the remote control.

Recording from the External Sources—Sound Synchronized Recording

With this recording method, playback and recording start automatically when the playback sound comes into this unit through the DIGITAL IN terminals, LINE IN jacks or MIC jack.

- Recording can be also stopped automatically when the playback sound stops coming in (see page 33).
- When you purchase this unit, digital recording from MDs, CDs or DATs is set to record the entire discs or tapes. If you want to record the tracks one by one, see page 34.

IMPORTANT

When using operating buttons (▶, ■, ||) on the remote control, check which indicator lights up on the display—CD PLAYER (3-CD Changer) or CD RECORDER. If the incorrect indicator is lit, press CONTROL CD or CONTROL CDR to select the correct target source.

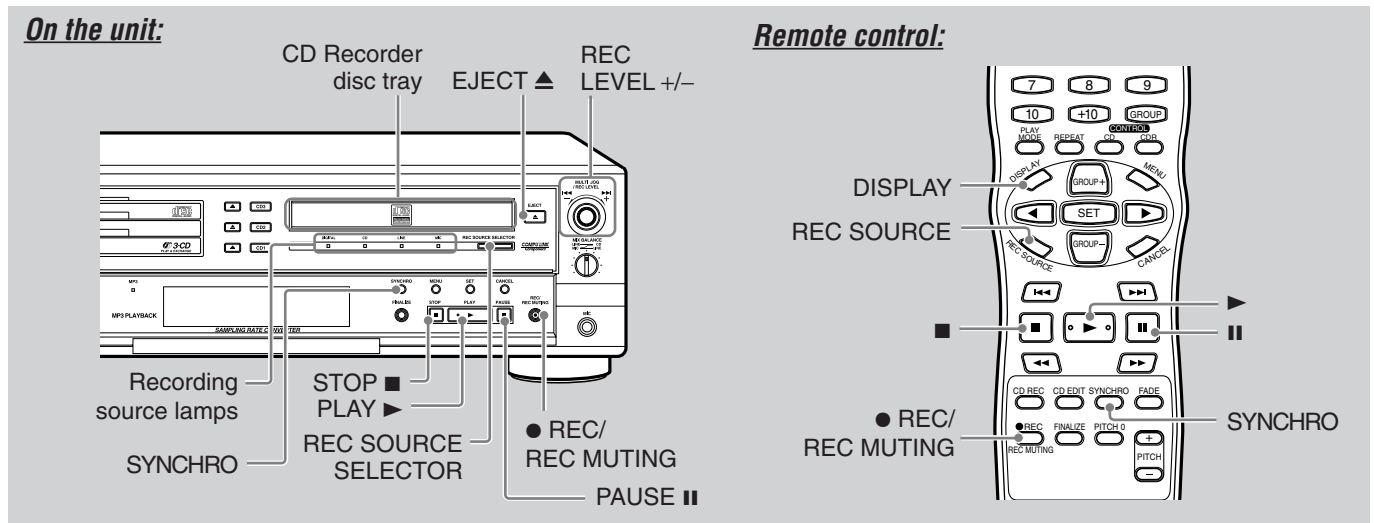

1 Load a recordable CD-R or CD-RW onto the CD Recorder disc tray.

2 Press REC SOURCE SELECTOR on the unit or REC SOURCE on the remote control to select a source to record from.

Selected recording source lamp on the unit lights up.

- OPTICAL IN** :Records through the DIGITAL IN/OPTICAL terminal (digital recording). The DIGITAL lamp lights up.
- COAXIAL IN** :Records through the DIGITAL IN/COAXIAL terminal (digital recording). The DIGITAL lamp lights up.
- LINE IN** :Records through the LINE IN (REC) jacks (analog recording). The LINE lamp lights up.
- MIC IN** :Records through the MIC jack (analog recording). The MIC lamp lights up.

3 Adjust the recording level if necessary—only for LINE IN and MIC IN.

See details on page 23.

4 Press SYNCHRO.

The unit enters recording pause mode and the SYNCHRO indicator lights up on the display. The remaining time of CD-R or CD-RW is shown on the display.

- If OPC (see page 42) is being performed, “UPDATE OPC” flashes on the display.

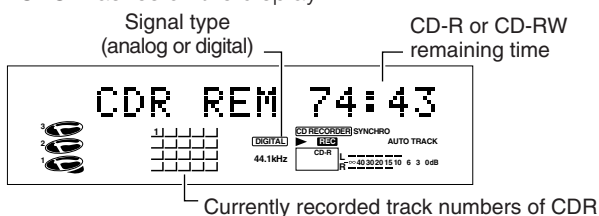

5 Start playback of the selected external component.

Recording starts automatically when the sound comes in.

To stop recording for a moment, press PAUSE || for CD Recorder on the unit or || on the remote control. To resume play, press PLAY ▶ for CD Recorder on the unit or ▶ on the remote control. (A track mark is recorded when you resume recording.)

To stop recording, press STOP ■ for CD Recorder on the unit or ■ on the remote control.

To eject the disc, press EJECT ▲.

“FINALIZE ?” appears on the display.

—To finalize, press FINALIZE or SET. After finalizing, the disc is ejected.

—Not to finalize, press EJECT ▲ again or wait for 5 seconds so that the disc comes out without being finalized.

To check the current track number during play, press DISPLAY on the remote control. The current track number appears for 3 seconds (see page 24).



- If “UNLOCK” appears on the display when selecting “OPTICAL IN” or “COAXIAL IN,” digital component connected to the DIGITAL IN terminals is not recognized. Check the connection.
- If Sound Synchronized Recording do not work correctly when “LINE IN” is selected as recording source, use the Standard Recording method (see page 22). If the sound signal is too weak for this unit to detect, Sound Synchronized Recording will not start (or will stop even while the source is being played).

Recording from the Two Sources Mixed—Sound Mixing Recording

You can record sounds mixing 2 sources. When using this method, analog recording is always performed.

- Recording can be also stopped automatically when the playback sound stops coming in (see page 33).
- While mixing, no sounds come out of the DIGITAL OUT terminals.

IMPORTANT

When using operating buttons (▶, ■, ||) on the remote control, check which indicator lights up on the display—CD PLAYER (3-CD Changer) or CD RECORDER. If the incorrect indicator is lit, press CONTROL CD or CONTROL CDR to select the correct target source.

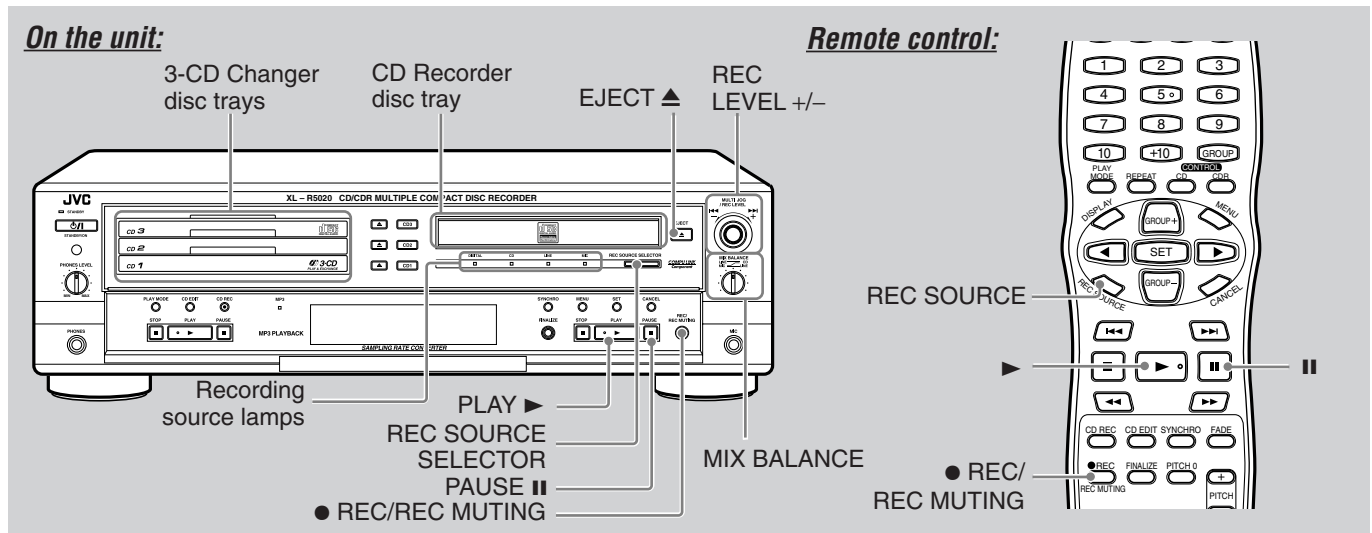

1 Load discs onto the 3-CD Changer disc trays and a recordable CD-R or CD-RW onto the CD Recorder disc tray.

2 Press **REC SOURCE SELECTOR** on the unit or **REC SOURCE** on the remote control to select a source to record from.

Selected recording source lamps on the unit light up.

CD+LINE MIX :Records mixed sound of 3-CD Changer and an external component through the LINE IN jacks. The CD and LINE lamps light up.

CD+MIC MIX :Records mixed sound of 3-CD Changer and a microphone through the MIC jack. The CD and MIC lamps light up.

LINE+MIC MIX :Records mixed sound of an external component through the LINE IN jacks and a microphone connected to the MIC jack. The LINE and MIC lamps light up.

3 Press ● **REC/REC MUTING**.

The unit enters recording pause mode. The remaining time of CD-R or CD-RW is shown on the display. The || and REC indicators light up on the display.

- If OPC (see page 42) is being performed, "UPDATE OPC" flashes on the display.

4 Start playback of the selected components or speaking into the microphone to adjust the recording level and mixing balance.

1) Adjust the recording level.

See details on page 23.

2) Turn MIX BALANCE control on the unit to adjust the mixing balance.

Source	MIX BALANCE LINE — CD MIC — LINE	MIX BALANCE LINE — CD MIC — LINE
CD+LINE	Reduce recording level of CD.	Reduce recording level of line input.
CD+MIC	Reduce recording level of CD.	Reduce recording level of microphone.
LINE+MIC	Reduce recording level of line input.	Reduce recording level of microphone.

5 When the adjustment is correctly done, stop playback of the selected components or speaking into the microphone.

6 Press ▶ **PLAY**.

Recording starts. The REC indicator flashes on the display.

7 Start playback of the selected components or speaking into the microphone.

To stop recording for a moment, press PAUSE || for CD Recorder on the unit or || on the remote control. To resume play, press PLAY ▶ for CD Recorder on the unit or ▶ on the remote control. (A track mark is recorded when you resume recording.)

To stop during recording, press STOP ■ for CD Recorder on the unit, or ■ on the remote control. "STOP DUBBING" flashes on the display for a while.

To eject the disc, press EJECT ▲.

"FINALIZE ?" appears on the display.

—To finalize, press FINALIZE or SET. After finalizing, the disc is ejected.

—Not to finalize, press EJECT ▲ again or wait for 5 seconds so that the disc comes out without being finalized.

Other Recording Functions

On the unit:

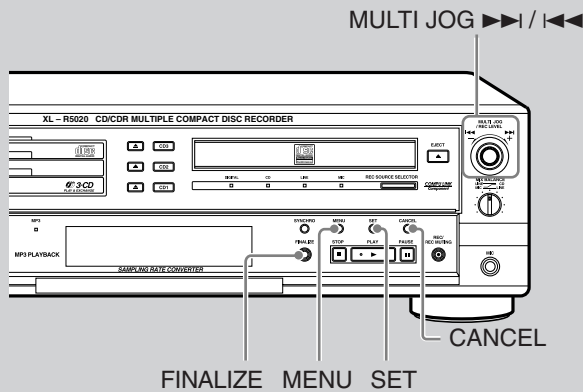

Remote control:

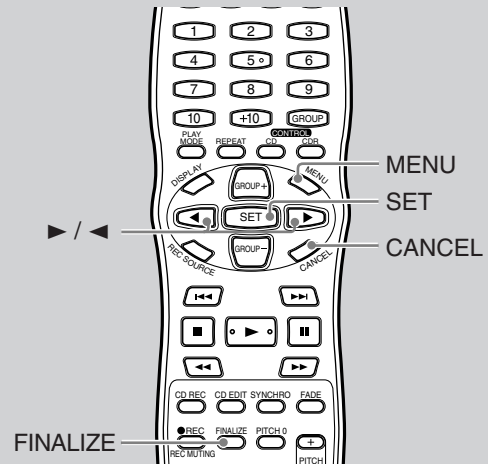

■ Setting auto-stop for analog Synchronized Recording

When using Synchronized Recording for recording from analog sources, you can stop recording automatically as well as starting. To use this function, follow the procedure below. Recording stops if weak signal that this unit cannot detect comes in for more than 6 seconds.

- When you purchase this unit, Synchronized Recording for analog sources is set to start automatically, but not to stop.

Available sources

CD ANALOG, LINE IN, MIC IN, CD+LINE MIX, CD+MIC MIX, LINE+MIC MIX

1 While 3-CD Changer and CD Recorder are in stop mode, press **MENU**.

2 Turn **MULTI JOG** ►► / ◀◀ on the unit or press ► or ◀ on the remote control until “ANALOG SYNC” appears on the display, then press **SET**.

“START” (initial setting) is flashing on the display.

- To cancel the setting, press **CANCEL**.

3 Turn **MULTI JOG** ►► / ◀◀ on the unit or press ► or ◀ on the remote control to select “START&STOP” then press **SET**.

To use Synchronized Recording only for the starting, select “START” in step 3.

■ Finalizing a disc—CD-R/CD-RW

Finalization is the final process in recording on a CD-R or CD-RW. “Finalizing a disc” means writing the TOC (Table of Contents) on the recorded disc.

Only after this process is completed, a recorded CD-R or CD-RW can be played back on a CD player compatible with CD-R/CD-RW.

IMPORTANT

- Once a CD-R has been finalized, no further recording can be made on the disc.
- When you unplug the power cord or when a power failure occurs during finalization process, recorded data will be lost and the disc may not be utilized any more if it is a CD-R.

1 Load a recorded disc you want to finalize onto the CD Recorder disc tray.

2 While 3-CD Changer and CD Recorder are in stop mode, press **FINALIZE**.

“FINALIZE?” appears on the display.

- If a finalized disc is loaded, “ALREADY FINAL” appears on the display.

3 Press **FINALIZE** again to finalize a disc.

Finalization starts. The REC indicator lights up and the ► indicator and “FINALIZE” start flashing on the display.

- Finalization requires a few minutes to complete. (When the disc is finalized, the REC indicator goes off, and the ► indicator and “FINALIZE” stop flashing then go off.)

To cancel the finalization, press **CANCEL** in step 2.

To unfinalize CD-RWs, see “Unfinalizing a disc—only for CD-RW” on the next page.

On the unit:

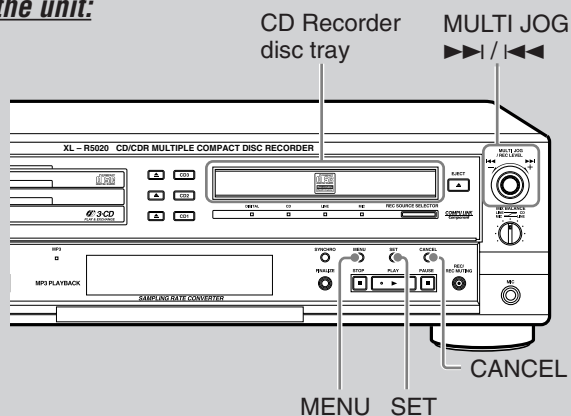

Remote control:

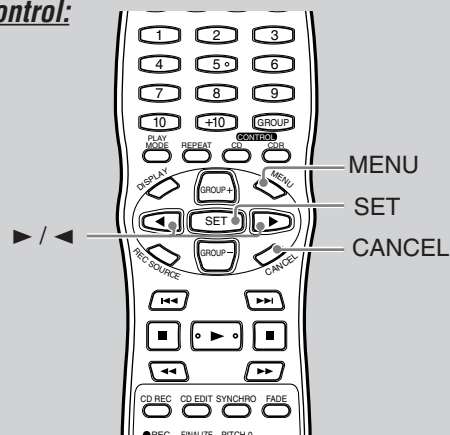

■ Unfinalizing a disc—only for CD-RW

By erasing the TOC (Table of Contents) of a finalized CD-RW, you will be able to record on the CD-RW again. This erasing process of the TOC is called “Unfinalization.”

- Unfinalization is just to erase the TOC, but not the recorded music signals on the disc.

IMPORTANT

When you unplug the power cord or when a power failure occurs while “UNFINALIZE” is flashing on the display, the disc may not be utilized any more.

1 Load a finalized disc you want to unfinalize on the CD Recorder disc tray.

The CD-RW and FINALIZED indicators light up on the display.

2 While 3-CD Changer and CD Recorder are in stop mode, press MENU.

3 Turn MULTI JOG ►►| / |◄◄ on the unit or press ► or ◄ on the remote control until “UNFINALIZE” appears on the display then press SET.

“UNFINALIZE?” appears on the display.

- If an unfinalized disc is loaded, “ALREADY UNFIN” appears on the display.

4 Press SET to unfinalize the disc.

Unfinalization starts. The REC indicator lights up and the ► indicator and “UNFINALIZE” start flashing on the display.

- Unfinalization requires a few minutes to complete. (When the disc is unfinalized, the REC indicator goes off and the ► indicator and “UNFINALIZE” stop flashing then go off.)

To cancel the unfinalization, press CANCEL in step 3.

■ Recording only one track from an external component

Digital recording from an MD recorder, a CD player, or a DAT deck connected to the DIGITAL IN terminals is initially set to record entire disc. You can also use Synchronized Recording for recording only one track. To use Synchronized Recording for one track, follow the procedure below.

Available source

OPTICAL IN, COAXIAL IN

1 While 3-CD Changer and CD Recorder are in stop mode, press MENU.

2 Turn MULTI JOG ►►| / |◄◄ on the unit or press ► or ◄ on the remote control until “DIG-IN SYNC” appears on the display, then press SET.

“SYNC ALL” (initial setting) appears on the display.

- To cancel the setting, press CANCEL.

3 Turn MULTI JOG ►►| / |◄◄ on the unit or press ► or ◄ on the remote control to select “SYNC 1-TRACK” then press SET.

To use Synchronized Recording for recording all tracks, select “SYNC ALL” in step 3.



Digital signal cannot be output through the DIGITAL OUT terminals while recording digitally from an external component.

■ Recording track marks manually

When auto track-marking is activated (initial setting), track marks are recorded automatically. To cancel auto track-marking and use manual track marking, follow the procedure below.

1 While 3-CD Changer and CD Recorder are in stop mode, press MENU.

2 Turn MULTI JOG ►►| / |◄◄ on the unit or press ► or ◄ on the remote control until “AUTO TRACK” appears on the display then press SET.

“AUTO TR ON” (initial setting) appears on the display.

- To cancel the setting, press CANCEL.

3 Turn MULTI JOG ►►| / |◄◄ on the unit or press ► or ◄ on the remote control to select “AUTO TR OFF,” then press SET.

The AUTO TRACK indicator goes off from the display, and auto track-marking is canceled. Now you can put track marks manually during recording.

To put track marks during recording manually, press SET at the point where you want to put a track mark. You can add up to 99 track marks.

To activate auto track-marking again, select "AUTO TR ON" in step 3.



- Track marks must be recorded apart from each other by 4 seconds. If you press SET twice within 4 seconds, the second press will be ignored (only one track mark will be recorded where you press SET for the first time).
- You cannot put track marks manually during CD Synchronized Recording. (Auto track-marking is activated temporarily.)

■ Separating recording tracks automatically

When this function is turned on, CD Recorder automatically places a 2-second blank space at the beginning of each track in recording (initial setting).

To turn off the function, follow the procedure below.

Available recording method

Standard Recording, Disc Direct Recording (except seamless recording), One Track Recording, Listening Edit Recording, Program Edit Recording

1 While 3-CD Changer and CD Recorder are in stop mode, press MENU.

2 Turn MULTI JOG ►►► / ◀◀◀ on the unit or press ► or ◀ on the remote control until "TRACK SPACE" appears on the display, then press SET.

"TR SPACE ON" (initial setting) appears on the display.

- To cancel the setting, press CANCEL .

3 Turn MULTI JOG ►►► / ◀◀◀ on the unit or press ► or ◀ on the remote control to select "TR SPACE OFF;" then press SET.

To activate automatic track spacing again, select "TR SPACE ON" in step 3.

■ Turning on or off sampling frequency rate converter

The sampling frequency rate converter built in CD Recorder allows you to record a digital source having sampling frequency (fs) of 32 kHz, 44.1 kHz, or 48 kHz. It can convert the fs of the source signals into 44.1 kHz so that CD Recorder can record the source.

When the sampling frequency converter is turned "OFF," digital signals are sent to CD Recorder bypassing the sampling frequency converter (without conversion).

Normally set it to "ON" (Initial setting). Only when you record dts* or HDCD*** signal coming through the DIGITAL IN terminals, turn off the sampling frequency rate converter. To turn off the converter, follow the procedure below.

1 While 3-CD Changer and CD Recorder are in stop mode, press MENU.

2 Turn MULTI JOG ►►► / ◀◀◀ on the unit or press ► or ◀ on the remote control until "CONVERTER" appears on the display, then press SET.

"CONVERTER ON" (initial setting) appears on the display.

- To cancel the setting, press CANCEL.

3 Turn MULTI JOG ►►► / ◀◀◀ on the unit or press ► or ◀ on the remote control to select "CONVERTER OFF;" then press SET.

To activate the converter, select "CONVERTER ON" in step 3.

- * dts is a trademark of Digital Theater Systems, Inc.
- **HDCD® is a registered trademark of Pacific Microsonic, Inc.

■ Recording skip marks onto a CD-R/CD-RW—Track Skip

Before finalizing a disc, you can record a skip mark to an unwanted track so that it will be skipped (ignored as if it does not exist) during play.

- You can record up to 21 skip marks on a disc.

IMPORTANT

- Once skip marks are recorded, they cannot be erased (you can only erase skip marks by erasing the tracks with skip marks).
- When you unplug the power cord or when a power failure occurs while "WRITE SKIP" is flashing on the display, the disc may not be utilized any more if it is a CD-R.

1 Load a recorded disc on the CD Recorder disc tray.

2 While 3-CD Changer and CD Recorder are in stop mode, press MENU.

3 Turn MULTI JOG ►►► / ◀◀◀ on the unit or press ► or ◀ on the remote control until "TRACK SKIP" appears on the display, then press SET.

"SKIP ?" appears on the display.

- To cancel the setting, press CANCEL.

4 Turn MULTI JOG ►►► / ◀◀◀ on the unit or press ► or ◀ on the remote control to select a track you want to skip, then press SET.

"WRITE SKIP" appears on the display and starts recording a skip track.

- The skip marked tracks are not shown on the track number indicators and the SKIP ON indicator lights up on the display.

5 To record skip marks for other tracks, repeat steps 2 and 4.



- "Skipping tracks during play" does not mean erasing recorded data. Therefore the remaining time of the disc will not change.
- Tracks with skip marks will be skipped only when playing the disc on CD Recorder and other CD player which can read these skip marks.

On the unit:

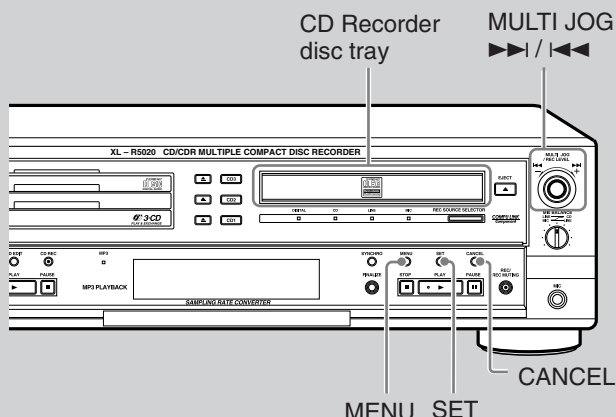

Remote control:

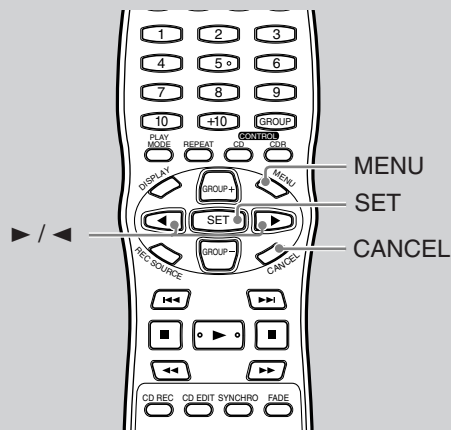

Erasing tracks (only for CD-RW)—Track Erase

Before finalizing a disc, you can erase recorded tracks—from a selected track up to the last track—on a **CD-RW** at a time.

- To erase recorded tracks on a finalized CD-RW, unfinalize the disc first (see page 34).

IMPORTANT

- Once erasure is performed, erased data cannot be restored.
- When you unplug the power cord or when a power failure occurs while “ERASE TRACK” is flashing on the display, the disc may not be utilized any more.

1 Load an unfinalized disc on the CD Recorder disc tray.

The total recorded track numbers and total playing time are shown on the display.

2 While 3-CD Changer and CD Recorder are in stop mode, press MENU.

3 Turn MULTI JOG $\blacktriangleright\blacktriangleright\blacktriangleright$ / $\blacktriangleleft\blacktriangleleft\blacktriangleleft$ on the unit or press \blacktriangleright or \blacktriangleleft on the remote control until “TRACK ERASE” appears on the display, then press SET.

The following message appears on the display.

- To cancel the erasing, press CANCEL.

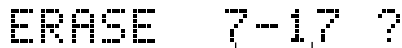

Erasing from this track number Last recorded track number

4 Turn MULTI JOG $\blacktriangleright\blacktriangleright\blacktriangleright$ / $\blacktriangleleft\blacktriangleleft\blacktriangleleft$ on the unit or press cursor \blacktriangleright or \blacktriangleleft on the remote control to select erasure start track, then press SET.

All the tracks between the selected track and the last one are erased.

- The erased track numbers go off from the track numbers indicators on the display.

Erasing all tracks (only for CD-RW)—Disc Erase

You can erase all the recorded tracks—whether or not finalized—on a **CD-RW** at a time.

IMPORTANT

- Once erasure is performed, erased data cannot be restored.
- When you unplug the power cord or when a power failure occurs while “ERASE DISC” is flashing on the display, the disc may not be utilized any more.

1 Load a recorded disc on the CD Recorder disc tray.

The all recorded track numbers and total playing time are shown on the display.

2 While 3-CD Changer and CD Recorder are in stop mode, press MENU.

3 Turn MULTI JOG $\blacktriangleright\blacktriangleright\blacktriangleright$ / $\blacktriangleleft\blacktriangleleft\blacktriangleleft$ on the unit or press \blacktriangleright or \blacktriangleleft on the remote control until “DISC ERASE” appears on the display, then press SET.

“ERASE DISC?” appears on the display.

- To cancel the setting, press CANCEL.

4 Press SET again.

The erasure starts. The REC indicator lights up, and the indicator and “ERASE DISC” start flashing on the display.

- Erasure requires a few minutes to complete. When erasure is done, “BLANK DISC” appears on the display.



Skip-marked tracks can also be erased.

Using the Timer

- Before using the timers—Daily Timer and Once Timer, you need to set the clock built in the unit.

On the unit:

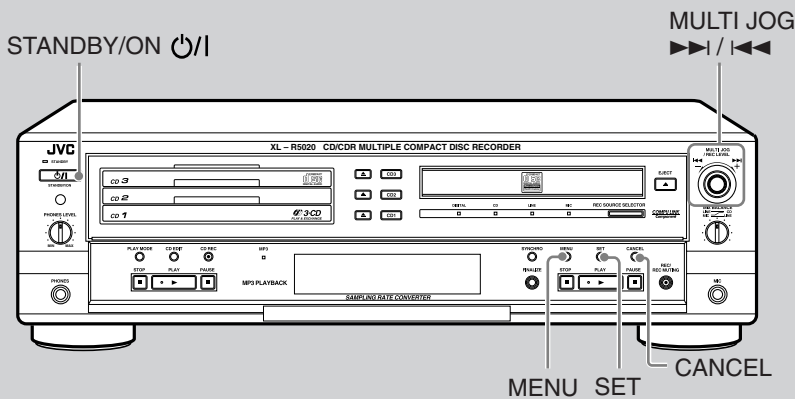

Remote control:

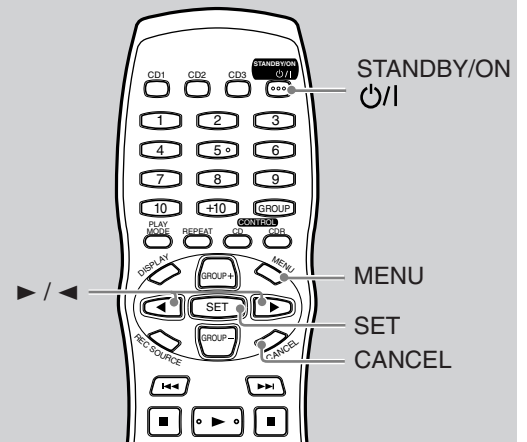

Setting the Clock

You can set the clock whether the unit is turned on or off (on standby).

To set the clock first time

1 When the unit is in standby mode

- 1) Press MENU.
"CLOCK SET" appears on the display.
- 2) Press SET.

When the unit is turned on

- 1) Press MENU.
- 2) Turn MULTI JOG ►►► / ◀◀◀ on the unit or press ► or ◀ on the remote control to select "CLOCK/TIMER" then press SET.

The hour digit on the display starts flashing.

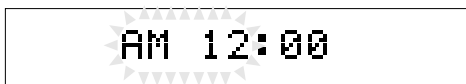

2 Turn MULTI JOG ►►► / ◀◀◀ on the unit or press ► or ◀ on the remote control to adjust the hour, then press SET.

The minute digit on the display starts flashing.

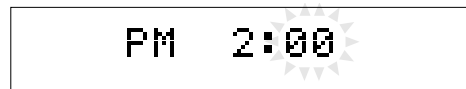

- To correct the hour after pressing SET, press CANCEL. The hour digit starts flashing again.

3 Turn MULTI JOG ►►► / ◀◀◀ on the unit or press ► or ◀ on the remote control to adjust the minute, then press SET.

The built-in clock starts working.

To adjust the clock again

You can adjust the clock whether the unit is turned on or off (on standby).

- 1 While 3-CD Changer and CD Recorder are in stop mode or the unit is in standby mode, press MENU.
- 2 Turn MULTI JOG ►►► / ◀◀◀ on the unit or press ► or ◀ on the remote control to select "CLOCK/TIMER" then press SET.
- 3 Turn MULTI JOG ►►► / ◀◀◀ on the unit or press ► or ◀ on the remote control to select "CLOCK SET" then press SET.
The hour digit on the display starts flashing.
- 4 Set the clock according to the procedure of the steps 2 and 3 on the left.



When you unplug the AC power cord or if a power failure occurs, the clock will be reset to "AM 12:00" and the timer memory will be erased. If this happens set the clock and the timer again.

Using Daily Timer and Once Timer

You can wake up to your favorite music (Playing Timer) or start recording sounds at the time you set (Recording Timer).

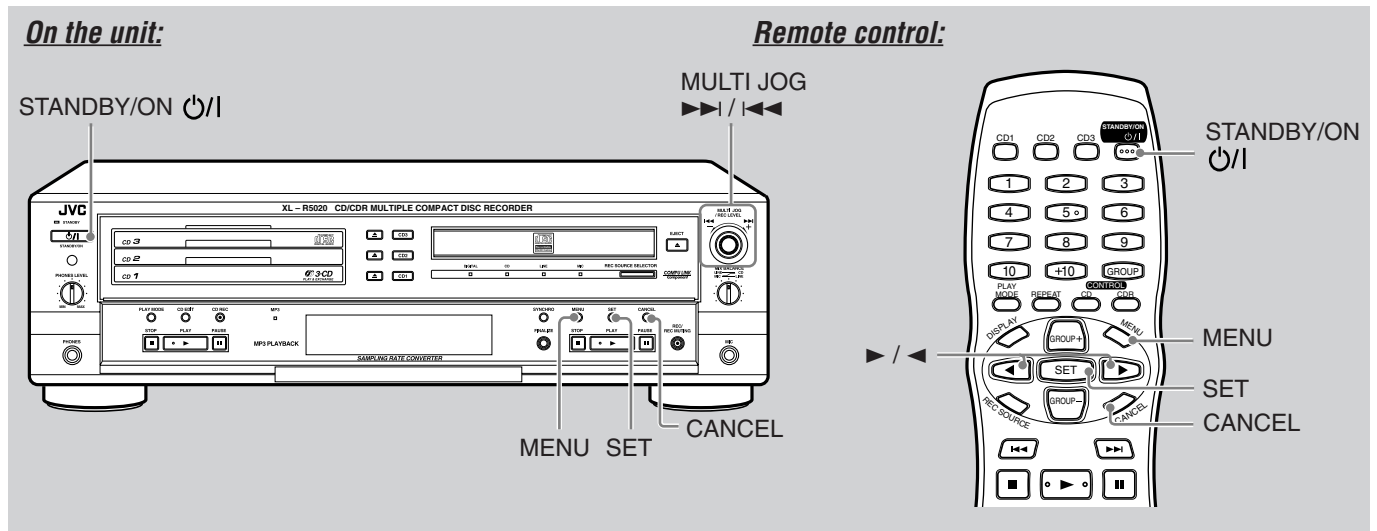

- You can set one Daily Timer and Once Timer whether the unit is turned on or off (on standby).
- To correct a misentry or cancel the setting any time during the process, press CANCEL.

How Timers actually work

The unit automatically turns on about 3 minutes before on-time, then starts playing/recording the specified source when the timer on-time comes. When the timer off-time comes, the unit automatically turns off (stands by).

Daily Timer activates every day; on the other hand, Once Timer will activate once, and then be canceled.

1 While 3-CD Changer and CD Recorder are in stop mode or the unit is in standby mode, press MENU.

2 Select “DAILY TIMER” or “ONCE TIMER.”

When the unit is turned on

- 1) Turn MULTI JOG ►►► / ◀◀◀ on the unit or press ► or ◀ on the remote control to select “CLOCK/TIMER,” then press SET.
- 2) Turn MULTI JOG ►►► / ◀◀◀ on the unit or press ► or ◀ on the remote control to select “DAILY TIMER” or “ONCE TIMER,” then press SET.

When the unit is in standby mode

Turn MULTI JOG ►►► / ◀◀◀ on the unit or press ► or ◀ on the remote control to select “DAILY TIMER” or “ONCE TIMER,” then press SET.

The Ⓢ (Timer) indicator lights up on the display. The unit enters on-time setting mode.



EX.: When selecting “DAILY TIMER.”

To activate the timer every day, select “DAILY TIMER.” The DAILY indicator also starts flashing on the display. To activate the timer once, select “ONCE TIMER.” The ONCE indicator also starts flashing on the display.

- Either ► (Playing Timer) or ● (Recording Timer) indicator also starts flashing.

3 Set the timer on-time.

- 1) Turn MULTI JOG ►►► / ◀◀◀ on the unit or press ► or ◀ on the remote control to set the hour, then press SET.
- 2) Turn MULTI JOG ►►► / ◀◀◀ on the unit or press ► or ◀ on the remote control to set the minute, then press SET.

The unit enters off-time setting mode.

4 Set the timer off-time.

- 1) Turn MULTI JOG ►►► / ◀◀◀ on the unit or press ► or ◀ on the remote control to set the hour, then press SET.
- 2) Turn MULTI JOG ►►► / ◀◀◀ on the unit or press ► or ◀ on the remote control to set the minute, then press SET.

The unit enters timer selection mode—Playing Timer or Recording Timer.

5 Turn MULTI JOG ►►► / ◀◀◀ on the unit or press ► or ◀ on the remote control to select “PLAY” or “REC,” then press SET.

- To use Playing Timer, select “PLAY.”
→ Go to “Setting Playing Timer.”
- To use Recording Timer, select “REC.”
→ Go to “Setting Recording Timer.”

Setting Playing Timer

6 Turn MULTI JOG ►► / ◀◀ on the unit or press ► or ◀ on the remote control to select the source—"CD" or "CDR," then press SET.

DAILY ► indicator or ONCE ► indicator stops flashing and remains lit. The setting you have done are shown on the display in sequence.

- CD:** Plays a disc in 3-CD Changer.
→ Prepare a disc, then press CD1, CD2 or CD3 you like to play.
- CDR:** Plays a disc in CD Recorder.
→ Prepare a disc.

7 Press STANDBY/ON ◻/I to turn off the unit (on standby) if you have set the timer with the unit turned on.

Adjust the volume level of the connected components.

Setting Recording Timer

6 Turn MULTI JOG ►► / ◀◀ on the unit or press ► or ◀ on the remote control to select the source, then press SET.

DAILY ► indicator or ONCE ► indicator stops flashing and remains lit. The setting you have done are shown on the display in sequence.

- Adjust the recording level if necessary (see page 23).

- OPTIC:** Records through the DIGITAL IN/OPTICAL terminal (digital recording).
- COAX:** Records through the DIGITAL IN/COAXIAL terminal (digital recording).
- LINE:** Records through the LINE IN (REC) jacks (analog recording).
- MIC:** Records through the MIC jack (analog recording).

- To operate an external component with Recording Timer, it also needs to have timer function.

7 Press STANDBY/ON ◻/I to turn off the unit (on standby) if you have set the timer with the unit turned on.

To turn off (or on) Playing Timer and Recording Timer after their settings are done

- 1 While 3-CD Changer and CD Recorder are in stop mode or the unit is in standby mode, press MENU.
- 2 To turn off Playing Timer or Recording Timer
When the unit is turned on
 - 1) Turn MULTI JOG ►► / ◀◀ on the unit or press ► or ◀ on the remote control to select "CLOCK/TIMER," then press SET.
 - 2) Turn MULTI JOG ►► / ◀◀ on the unit or press ► or ◀ on the remote control to select "DAILY TIMER" or "ONCE TIMER," then press CANCEL.

When the unit is in standby mode

Turn MULTI JOG ►► / ◀◀ on the unit or press ► or ◀ on the remote control to select "DAILY TIMER" or "ONCE TIMER," then press CANCEL.

To turn on Playing Timer or Recording Timer

When the unit is turned on

- 1) Turn MULTI JOG ►► / ◀◀ on the unit or press ► or ◀ on the remote control to select "CLOCK/TIMER," then press SET.
- 2) Turn MULTI JOG ►► / ◀◀ on the unit or press ► or ◀ on the remote control to select "DAILY TIMER" or "ONCE TIMER," then press SET.

When the unit is in standby mode

Turn MULTI JOG ►► / ◀◀ on the unit or press ► or ◀ on the remote control to select "DAILY TIMER" or "ONCE TIMER," then press SET.



- If the unit is kept turned on when the timer on-time comes, Timer does not work at all.
- The timer settings remain stored in memory until you reset them.

Timer Priority

- When Daily Timer and Once Timer overlap, the timer for which on-time is set earlier works.

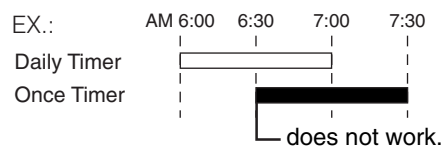

- When both Daily Timer and Once Timer are set to start at the same time, Once Timer has priority.

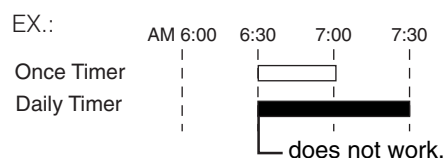

COMPU LINK Remote Control System

The COMPU LINK remote control system allows you to operate JVC's audio components like this unit through the remote sensor on a receiver (amplifier).

Connection

To use this remote control system, you need to connect JVC's audio components through the COMPU LINK-4 (SYNCHRO) or COMPU LINK-3 (SYNCHRO) jacks (see below) in addition to the connections using audio cables with RCA pin plugs (see page 7).

- Make sure that the AC power cords of these components are unplugged before connection. Plug the AC power cords only after all connections are complete.
- When using COMPU LINK remote control system for operating a receiver (amplifier) equipped with TAPE and/or CDR jacks, set the MODE selector to the appropriate position (see page 7).

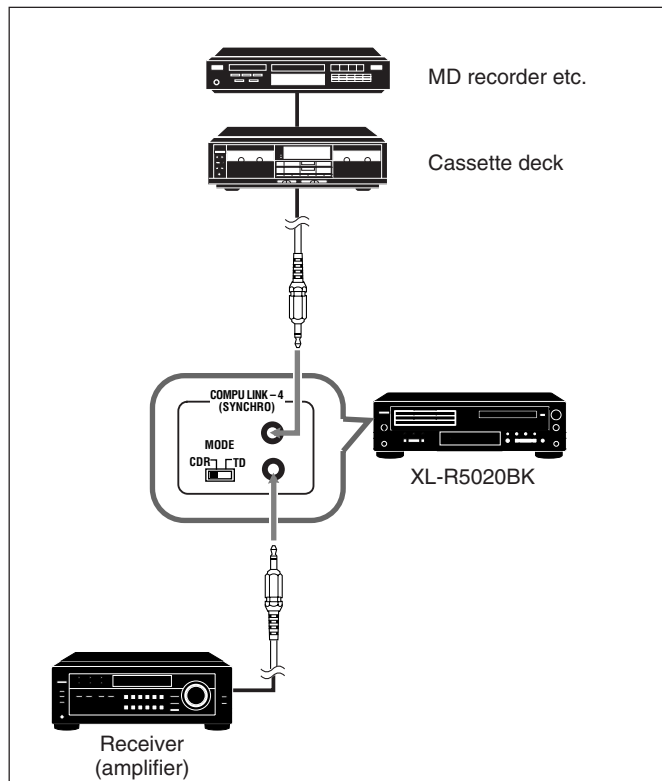

Available functions

This remote control system allows you to use the functions listed below.

Automatic source selection

This unit will turn on (or off) automatically:

- when you turn on (or off) the receiver (amplifier), and
- when you select TAPE or CDR on the receiver (amplifier).

Automatic power on/off (standby): only possible with the COMPU LINK-3 and COMPU LINK-4

- When pressing the buttons listed below, the source is changed to TAPE or CDR on the connected receiver (amplifier):
 - PLAY ► for 3-CD Changer on the unit
 - PLAY ► for CD Recorder on the unit
 - Disc number buttons (CD1, CD2 or CD3)
 - on the remote control
- When this unit is selected (TAPE or CDR) as the source on a receiver (amplifier), the currently selected disc on this unit—3-CD Changer or CD Recorder—will start playing.



- There are four versions of COMPU LINK remote control system. This unit is equipped with the fourth version—COMPU LINK-4 which has systematic operations with the CD recorder added to the previous version—COMPU LINK-3.
- If your audio component has two COMPU LINK jacks, you can use either one. If it has only one COMPU LINK jack, connect it so that it is the last item in the series of components.
- You cannot use the number buttons on the remote control supplied with a receiver (amplifier). Use the remote control supplied with this unit.
- You cannot use synchronized recording by using COMPU LINK remote control system.
- Refer also to the manuals supplied with your audio components.

Maintenance

To get the best performance of the unit, keep your discs and mechanism clean.

General Notes

In general, you will have the best performance by keeping your discs and the mechanism clean.

- Store discs in their cases, and keep them in cabinets or on shelves.
- Keep the disc trays closed when not in use.

To handle discs

When removing a disc from its case, press down the center holder of the case and lift the disc out, holding it by the edges.

- Always hold the disc by the edges. Do not touch its recording surface.
When storing a disc into its case, gently insert the disc around the center holder (with the printed surface facing up).
- Make sure to store discs into the cases after use.
- Be careful not to scratch the surface of the disc when placing it back in its case.
- Avoid exposure to direct sunlight, temperature extremes, and moisture.

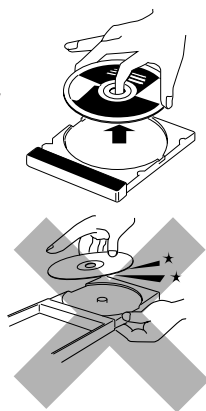

To clean the disc

Wipe the disc with a soft cloth in a straight line from center to edge.



DO NOT use any solvent—such as conventional record cleaner, spray, thinner, or benzine—to clean the disc.

To play new discs

New discs may have some rough spots around the inner and outer edges. If such a disc is used, this unit may reject the disc.

To remove these rough spots, rub the edges with a pencil or ballpoint pen, etc.

Moisture condensation

Moisture may condense on the lenses inside the unit in the following cases:

- After starting the heater.
- When the unit is moved from the extremely hot place to the extremely cold place.

Should this occur, the unit may malfunction. In this case, eject the disc and leave the unit turned on for a few hours until the moisture evaporates.



- DO NOT expose discs to direct sunlight or any heat source or place them in a place subject to high temperature and humidity.
- DO NOT leave discs in a car.

To clean the unit

- Stains on the unit
Should be wiped off with a soft cloth. If the unit is heavily stained, wipe it with a cloth soaked in water-diluted neutral detergent and wrung well, then wipe clean with a dry cloth.
- Since the unit may deteriorate in quality, become damaged or get its paint peeled off, be careful about the followings.
 - DO NOT wipe it with a hard cloth.
 - DO NOT wipe it strong.
 - DO NOT wipe it with thinner or benzine.
 - DO NOT apply any volatile substance such as insecticides to it.
 - DO NOT allow any rubber or plastic to remain in contact with it for a long time.

OPC (Optimum Power Control)

OPC is a function that checks the loaded disc and automatically adjusts the laser for optimum recording setting before recording.

PCA (Power Calibration Area)

A space reserved at the beginning of a CD-R/CD-RW for calibrating the laser output power required to record on that disc.

PMA (Program Memory Area)

A temporary memory area on a CD-R/CD-RW, where the information about the recordings on the disc—track numbers, tracks' start points and end points, etc. is stored until the disc is finalized.

When the disc is finalized, this information is written in the TOC (see below).

Sampling Frequency

When analog signal are converted into digital signals, they are divided into many points and digitized. This dividing method is called "sampling." The sampling frequency indicates how many points one second is divided into—for example, for CD sound, one second is divided into 44 100 points since its sampling frequency is 44.1 kHz.

SCMS (Serial Copy Management System)

Digital audio components, such as CD recorder, MD (Mini-Disc) recorder and DAT (Digital Audio Tape) recorder, can exchange audio signal in the digital forms through digital input/output terminals. The digital audio components allow digital copy of music signal with little deterioration. This has made it necessary to have a copy restriction rule for protecting the copyright, and "SCMS (Serial Copy Management System)" has been established as a result.

To protect the copyright, the SCMS allows only first-generation digital copies to be made from premastered software (like CDs or prerecorded MDs).

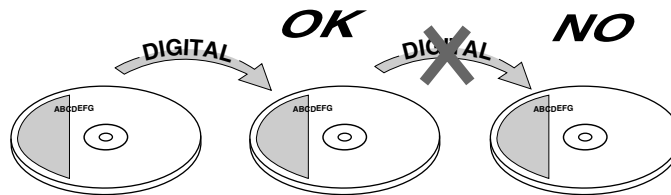

TOC (Table of Contents)

TOC is a kind of disc information containing sub-data (track number, playing time, etc.) that enables us to search for tracks quickly on the disc.

To write the TOC on a CD-R or CD-RW, you need to finalize the disc.

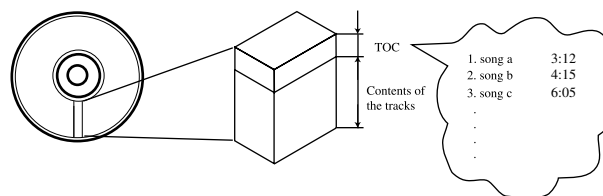

Message

Message	Signification	Solution
ALL SKIP TR	Skip marks are recorded to all the tracks.	Replace the disc.
ALREADY FINAL	You are trying to record on a finalized disc.	Replace the disc.
ALREADY UNFIN.	You are trying to unfinalize an unfinalized disc.	_____
BLANK DISC	No track is recorded on the loaded disc.	_____
CANNOT ERASE	Loaded CD-RW disc is damaged. Erasure on this disc is impossible.	_____
CANNOT FIN.	Loaded disc is damaged. Finalization on this disc is impossible.	Replace the disc.
CANNOT PLAY	On 3-CD Changer, damaged disc is loaded or an MP3 disc is detected during Program Play and Random Play.	_____
CANNOT REC	Recording on this disc is impossible due to the disc type—for example, an MP3 disc, and to incorrect connection.	Check the disc or connection.
CANNOT UNFIN.	Loaded CD-RW disc is damaged. Unfinalization on this disc is impossible.	Replace the disc.
CDR DISC NG	Loaded CD-R is damaged.	Replace the disc.
DAO DISC	You are trying to unfinalize a CD-RW which has been recorded using the “Disc At Once” recording system.	Replace the disc.
DISC FULL	You are trying to record on a fully recorded CD-R or CD-RW.	Replace the disc.
NOT AUDIO IN	Incoming digital signal from the external component is not of an audio format.	Check the source played on the external component connected to the DIGITAL IN terminals.
NOT REC MUTE	You are trying to use the REC MUTE button during Synchronized Recording.	You can only use the REC MUTE button during Standard Recording.
NO AUDIO DISC	Loaded disc is not an audio disc or an MP3 disc.	Replace the disc.
NO RW DISC	You are trying to perform one of the functions for a CD or CD-R which is only possible on a CD-RW.	Load a CD-RW.
NO R/RW DISC	You are trying to perform one of the functions for a CD which is only possible on a CD-R or CD-RW.	Load a CD-R or CD-RW.
OPC ERROR	OPC cannot be performed. No recording or erasure can be performed on this disc.	Replace the disc.
OPC FULL	OPC is full. No recording or erasure can be performed on this disc.	Replace the disc.
PMA FULL	PMA is full. No recording or erasure can be performed on this disc.	Replace the disc.
SCMS PROTECT	Digital recording is prohibited in accordance with SCMS regulations.	See “SCMS” on page 42.
SHORT REMAIN	The remaining time on a disc is shorter than the playing time of the track you are trying to record.	_____
SKIP FULL	21 skip marks are already recorded.	To record skip marks, delete skip-marked tracks first. See page 35.
TNO FULL	99 tracks have been recorded. No further recording is possible.	To record other tracks, delete unwanted tracks first (CD-RW only).
TRAY LOCKED	You are trying to eject a disc while Tray Lock is in use.	Unlock Tray Lock (see page 15).
UNLOCK	The external digital component is not connected properly or is turned off, or its signals are incompatible.	Check the connection, or playback source.
UPDATE OPC	OPC is being performed before recording, when a disc is just inserted in CD Recorder.	This is normal. After OPC is correctly done, recording starts.

Troubleshooting

If you are having a problem with your unit, check this list for a possible solution before calling for service. If you cannot solve the problem from the hints given here, or the unit has been physically damaged, call a qualified person, such as your dealer, for service.

	Symptom	Possible Cause	Action
3-CD Changer/ CD Recorder	The disc does not play.	<ul style="list-style-type: none"> The disc is loaded upside down. Data CD-ROM is loaded. 	<ul style="list-style-type: none"> Load the disc with the label side up. Data CD-ROM cannot be played back. Replace the disc.
	The disc play is skipped.	The disc is dirty or scratched.	Clean or replace the disc. (See page 41.)
	Loaded discs cannot be ejected.	<ul style="list-style-type: none"> AC power cord is unplugged. Tray Lock is in use. 	<ul style="list-style-type: none"> Plug in the AC power cord. Unlock Tray Lock. (See page 15.)
CD Recorder	Unable to record on a CD-R or CD-RW.	<ul style="list-style-type: none"> Finalized CD-R or CD-RW is loaded. 	<ul style="list-style-type: none"> CD-R: Replace the disc. CD-RW: Unfinalize the disc. (See page 34.)
		<ul style="list-style-type: none"> Selecting MP3 tracks for recording. 	<ul style="list-style-type: none"> Cannot record MP3 tracks. Replace the disc.
		<ul style="list-style-type: none"> Digital recording is tried to perform from a digitally dubbed disc. 	<ul style="list-style-type: none"> Select analog recording. (See page 22.)
<ul style="list-style-type: none"> The disc is loaded upside down. Disc is dirty or scratched. 		<ul style="list-style-type: none"> Load the disc with the label side up. Clean or replace the disc. (See page 41.) 	
No sound is heard while recording.	High-speed recording is selected.	Select normal speed. (See page 25.)	
General	Unable to operate the remote control.	<ul style="list-style-type: none"> The path between the remote control and the remote sensor on the unit is blocked. The batteries have lost their charge. 	<ul style="list-style-type: none"> Remove the obstruction. Replace the batteries. (See page 6.)
	The clock is flashing on the display.	AC power cord is unplugged or power failure occurs.	Set the clock and timer again.
	Operations are disabled.	The built-in microprocessor has malfunctioned due to external electrical interference.	Unplug the unit then plug it back in.

IMPORTANT

- If you are going to record something important, always test-record first to check that the recording turns out properly before proceeding with the actual recording.
- The manufacturer assumes no liability whatsoever for any damage resulting from missed opportunity or accidental erasure that occurs while conducting recording or playback operations due to malfunctioning of or trouble in the unit, or for any incidental damage.

Common specification

Audio input sensitivity/Impedance (at 1 kHz)

Analog input:

LINE IN (REC): 300 mV/50 k Ω

MiC IN: 3 mV/600 Ω – 10 k Ω

Digital input:

DIGITAL IN: OPTICAL

Input level: -21 dBm to -15 dBm

DIGITAL IN: COAXIAL

0.5 V(p-p)/75 Ω

(With the built-in sampling rate converter, corresponding to 32 kHz/44.1 kHz/48 kHz)

Audio output level/Impedance (at 1 kHz)

Analog output:

LINE OUT (PLAY): 2 V/10 k Ω

HEADPHONE: 9.3 mW/ 32 Ω

Digital output:

DIGITAL OUT: OPTICAL

Output level: -21 dBm to -15 dBm

DIGITAL OUT: COAXIAL

0.5 V(p-p)/75 Ω

CD player

System: Compact disc digital audio system

CD Capacity: 3 CDs

Dynamic range: 96 dB

Signal-to-noise ratio: 100 dB

Frequency response: 4 Hz to 20 kHz (± 0.5 dB)

Wow and flutter: Immeasurable

Pitch control: $\pm 12\%$

Total harmonic distortion: 0.005 %

CD recorder

System: Compact disc digital audio recording system

Sampling frequency: 44.1 kHz

Dynamic range: 91 dB (during playback)

Signal-to-noise ratio: 95 dB (during playback)

Frequency response: 4 Hz to 20 kHz

Wow and flutter: Immeasurable

Total harmonic distortion: 0.0063 %

General

Power requirement: AC 120 V \sim , 60 Hz

Power consumption: 37 W (at operation)

5 W (on standby)

Dimensions (approx.): 435 mm \times 127 mm \times 334 mm

(17 $^{-3/16}$ inch \times 5 inch \times 13 $^{-3/16}$ inch)(W/H/D)

Mass (approx.): 6.3 kg (13.9 lbs)

Supplied accessories

See page 6.

Design and specifications are subject to change without notice.

Authorized Service Centers

QUALITY **JVC**[®] SERVICE

HOW TO LOCATE YOUR JVC SERVICE CENTER

TOLL FREE: 1 (800) 537-5722

<http://www.jvc.com>

Dear Customer,

In order to receive the most satisfaction from your purchase, please read the instruction booklet before operating the unit. In the event that repairs are necessary, please call 1 (800)537-5722 for your nearest authorized servicer or visit our website at **www.JVC.com**

Remember to retain your Bill of Sale for Warranty Service.

Do not service the television yourself

Caution

To prevent electrical shock, do not open the cabinet. There are no user serviceable parts inside. Please refer to qualified service personnel for repairs.

Accessories

To purchase accessories for your JVC product, please call toll free: 1 (800)882-2345 or on the web at **www.JVC.com**



LIMITED WARRANTY

AUDIO-1

JVC COMPANY OF AMERICA warrants this product and all parts thereof, except as set forth below ONLY TO THE ORIGINAL PURCHASER AT RETAIL to be FREE FROM DEFECTIVE MATERIALS AND WORKMANSHIP from the date of original retail purchase for the period as shown below. ("The Warranty Period")

PARTS	1 YR	LABOR	1 YR
-------	-------------	-------	-------------

THIS LIMITED WARRANTY IS VALID ONLY IN THE FIFTY (50) UNITED STATES, THE DISTRICT OF COLUMBIA AND IN COMMONWEALTH OF PUERTO RICO.

WHAT WE WILL DO:

If this product is found to be defective, JVC will repair or replace defective parts at no charge to the original owner. Such repair and replacement services shall be rendered by JVC during normal business hours at JVC authorized service centers. Parts used for replacement are warranted only for the remainder of the Warranty Period. All products and parts thereof may be brought to a JVC authorized service center on a carry-in basis except for Television sets having a screen size 25 inches and above which are covered on an in-home basis.

WHAT YOU MUST DO FOR WARRANTY SERVICE:

Return your product to a JVC authorized service center with a copy of your bill of sale. For your nearest JVC authorized service center, please call toll free: (800) 537-5722.

If service is not available locally, box the product carefully, preferably in the original carton, and ship, insured, with a copy of your bill of sale plus a letter of explanation of the problem to the nearest JVC Factory Service Center, the name and location of which will be given to you by the toll-free number.

If you have any questions concerning your JVC Product, please contact our Customer Relations Department.

WHAT IS NOT COVERED:

This limited warranty provided by JVC does not cover:

1. Products which have been subject to abuse, accident, alteration, modification, tampering, negligence, misuse, faulty installation, lack of reasonable care, or if repaired or serviced by anyone other than a service facility authorized by JVC to render such service, or if affixed to any attachment not provided with the products, or if the model number or serial number has been altered, tampered with, defaced or removed;
2. Initial installation and installation and removal for repair;
3. Operational adjustments covered in the Owner's Manual, normal maintenance, video and audio head cleaning;
4. Damage that occurs in shipment, due to act of God, and cosmetic damage;
5. Signal reception problems and failures due to line power surge;
6. Video Pick-up Tubes/CCD Image Sensor, Cartridge, Stylus (Needle) are covered for 90 days from the date of purchase;
7. Accessories
8. Batteries (except that Rechargeable Batteries are covered for 90 days from the date of purchase);

There are no express warranties except as listed above.

THE DURATION OF ANY IMPLIED WARRANTIES, INCLUDING THE IMPLIED WARRANTY OF MERCHANTABILITY, IS LIMITED TO THE DURATION OF THE EXPRESS WARRANTY HEREIN.

JVC SHALL NOT BE LIABLE FOR THE LOSS OF USE OF THE PRODUCT, INCONVENIENCE, LOSS OR ANY OTHER DAMAGES, WHETHER DIRECT, INCIDENTAL OR CONSEQUENTIAL (INCLUDING, WITHOUT LIMITATION, DAMAGE TO TAPES, RECORDS OR DISCS) RESULTING FROM THE USE OF THIS PRODUCT, OR ARISING OUT OF ANY BREACH OF THIS WARRANTY. ALL EXPRESS AND IMPLIED WARRANTIES, INCLUDING THE WARRANTIES OF MERCHANTABILITY AND FITNESS FOR PARTICULAR PURPOSE, ARE LIMITED TO THE WARRANTY PERIOD SET FORTH ABOVE.

Some states do not allow the exclusion of incidental or consequential damages or limitations on how long an implied warranty lasts, so these limitations or exclusions may not apply to you. This warranty gives you specific legal rights and you may also have other rights which vary from state to state.

JVC COMPANY OF AMERICA 1700 Valley Road
 DIVISION OF JVC AMERICAS CORP. Wayne, NJ 07470

REFURBISHED PRODUCTS CARRY A SEPARATE WARRANTY, THIS WARRANTY DOES NOT APPLY. FOR DETAILS OF REFURBISHED PRODUCT WARRANTY, PLEASE REFER TO THE REFURBISHED PRODUCT WARRANTY INFORMATION PACKAGED WITH EACH REFURBISHED PRODUCT.

For customer use:	
Enter below the Model No. which is located either on the rear, bottom or side of the cabinet. Retain this information for future reference.	
Model No. :	Serial No. :
Purchase data :	Name of dealer :

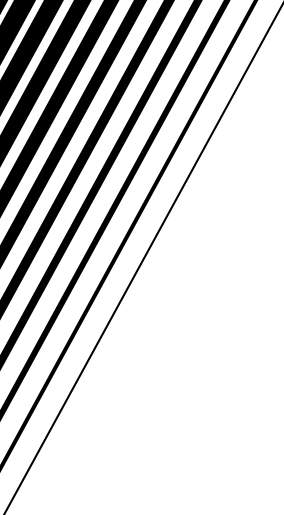

JVC
VICTOR COMPANY OF JAPAN, LIMITED